

**Learning about the Constitution of the Republic of South Africa (1996)**

The Constitution of South Africa (1996) is the highest law in the country. This law is higher than the President, higher than the courts and higher than the government.

It describes how the people of our country should treat each other, and what their rights and responsibilities are. The constitution of a country is there to protect all of us now, and our children in the future.

**Be aware of our past.**

**Let us not repeat the mistakes of past.**

**Our Constitution helps us to imagine and build a better future for all.**

We, the people of South Africa;

Recognise the injustices of our past;

Honour those who suffered for justice and freedom in our land;

Respect those who have worked to build and develop our country; and

Believe that South Africa belongs to all who live in it, united in our diversity.

We therefore, through our freely elected representatives, adopt this Constitution as law of the Republic so as to—

Heal the division of the past and establish a society based on democratic values, social justice and fundamental human rights;

Lay the foundations for a democratic and open society in which government is based on the will of the people and every citizen is equally protected by law;

Improve the quality of life of all citizens and free the potential of each person; and

Build a united and democratic South Africa able to take its rightful place as a Sovereign state in the family of nations.

**Claim your rights as a South African and be responsible to protect the rights of others.**

**Know your Bill of rights & Bill of Responsibilities.**

*May God protect our people.*

*Nkosi Sikelel' iAfrika. Morena boloka setjhaba sa heso.*

*God seën Suid-Afrika. God bless South Africa.*

*Mudzimu fhatutshedza Afurika. Hosi katekisa Afrika.*



ISBN 978-1-4315-0004-8



9 781431 500048



**MATHEMATICS IN ENGLISH  
GRADE 3 – BOOK 1**

**TERMS 1 & 2**

**ISBN 978-1-4315-0004-8**

THIS BOOK MAY NOT BE SOLD.

**11th Edition**



MATHEMATICS IN ENGLISH – Grade 3 Book 1

ISBN 978-1-4315-0004-8

Revised and CAPS aligned

Grade 3

Name:

Class:



**basic education**

Department:  
Basic Education  
REPUBLIC OF SOUTH AFRICA

MATHEMATICS IN ENGLISH

Book 1  
Terms 1 & 2



# Contents

No.	Title	Pg.
1	Count, sort and show!	2
2	Clever counting	4
3a	Numbers on a hundred board	6
3b	Numbers on a hundred board (continued)	8
4	Place value	10
5	Addition and subtraction	12
6	Doubles and halves	14
7	Fractions	16
8	Sorting money	18
9	Patterns	20
10	Balls, boxes and cylinders	22
11	Draw, name and compare 2D shapes	24
12	Time passes	26
13	Measuring length	28
14	Capacity	30
15	Working with mass	32
16	Data handling	34
17	Compare and order numbers	36
18	Place value to 99	38
19	Putting tens together when we add to 99	40
20a	Add on a number line	42
20b	Add on a number line (continued)	44
21a	Subtract on a number line	46
21b	Subtract on a number line (continued)	48
22	It's party time	50
23	Counting up to 200	52
24	Practice with 5s	54
25a	Count in 2s	56
25b	Count in 2s (continued)	58
26	Money then and now	60
27	Count in 3s	62
28	What comes in 4s?	64
29	Patterns in numbers	66
30a	Division	68
30b	Division (continued)	70
31	Fractions	72
32	It's about time	74

No.	Title	Pg.
33	Target 200	76
34	Working with groups of numbers	78
35a	Putting tens together and taking them apart	80
35b	Putting tens together and taking them apart (continued)	82
36	A visit to the dentist	84
37a	Add and combine	86
37b	Add and combine (continued)	88
38	Solve it!	90
39	Count and calculate	92
40	Measuring in centimetres	94
41	Target 300	96
42	Adding and subtracting with 100s	98
43	Target 400	100
44	Weighing in	102
45	Target 500	104
46	More adding and subtracting	106
47	Sharpen your skills	108
48	Symmetry	110
49	Building up to 500	112
50	Multiplication and division (10)	114
51	Count in 2s	116
52	Pave with tiles	118
53	Using fives	120
54	Working with time	122
55	Count in 3s and 4s	124
56	Count in 50s	126
57	Fractions: halves and quarters	128
58	Fractions: halves, thirds and sixths	130
59	Fractions: fifths	132
60	3D objects	134
61	Double and half	136
62	More double and halving	138
63	Group and combine	140
64	Maths fun	142
	Cut-out 1	
	Cut-out 2	



Mrs Angie Motshekga,  
Minister of Basic  
Education



Dr Reginah Mhaule,  
Deputy Minister  
of Basic Education

These workbooks have been developed for the children of South Africa under the leadership of the Minister of Basic Education, Mrs Angie Motshekga, and the Deputy Minister of Basic Education, Dr Reginah Mhaule.

The Rainbow Workbooks form part of the Department of Basic Education's range of interventions aimed at improving the performance of South African learners in the first six grades. As one of the priorities of the Government's Plan of Action, this project has been made possible by the generous funding of the National Treasury. This has enabled the Department to make these workbooks, in all the official languages, available at no cost.

We hope that teachers will find these workbooks useful in their everyday teaching and in ensuring that their learners cover the curriculum. We have taken care to guide the teacher through each of the activities by the inclusion of icons that indicate what it is that the learner should do.

We sincerely hope that children will enjoy working through the book as they grow and learn, and that you, the teacher, will share their pleasure.

We wish you and your learners every success in using these workbooks.

Grade 3



# Mathematics

IN ENGLISH

*This book belongs to:*

---



ENGLISH

Book



Date: \_\_\_\_\_

# Count, sort and show!

Term 1



How many stars?

Compare answers.

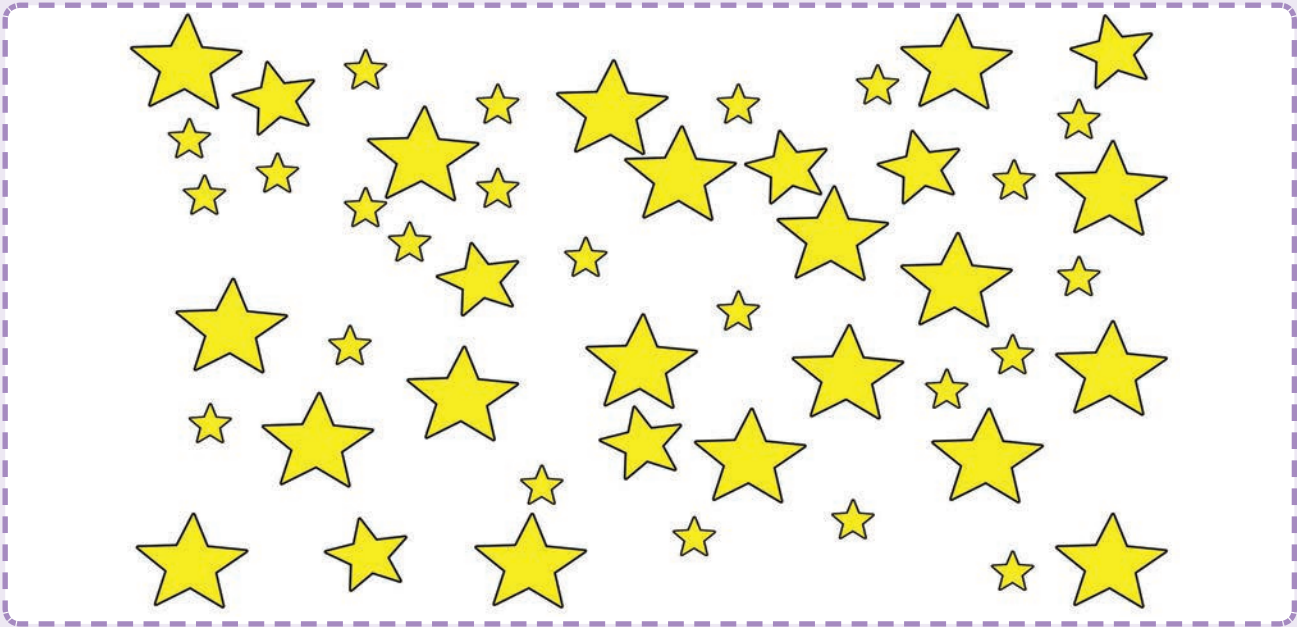

Estimate how many stars. \_\_\_\_\_

Now count them. \_\_\_\_\_



Find the winner!

Who made the best estimate?

Fill in your names and answers in this table.

Name				
Estimate				
Number counted				
Difference between your estimate and your count				





Ways to count. Help us to write it down.



I counted in ones.

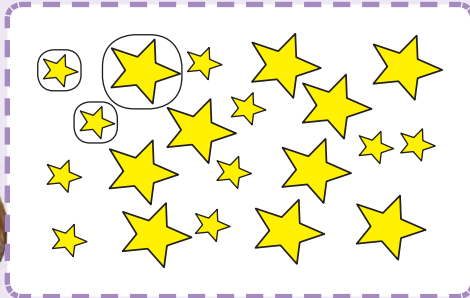

1, 2, 3, \_\_\_\_\_  
\_\_\_\_\_

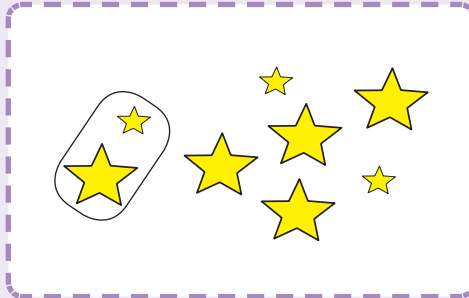

2, \_\_\_\_\_  
\_\_\_\_\_



I counted in twos.



I counted in fives.

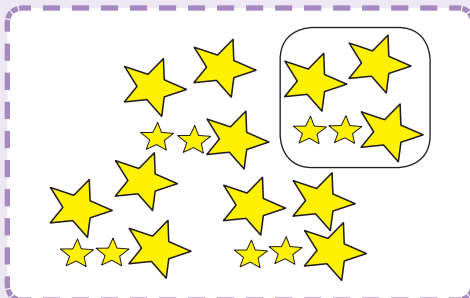

5, \_\_\_\_\_  
\_\_\_\_\_



\_\_\_\_\_



I counted in tens.



Write number sentences

Count the total number of big and small stars in the picture on page 2.

Write them in two ways.

Big    Small    like this    or    like this

$$\text{Big Star} + \text{Small Star} = \underline{\hspace{2cm}}$$

When you add any two numbers it does not matter what their order is.

$$\text{Small Star} + \text{Big Star} = \underline{\hspace{2cm}}$$

and as a number sentence.

\_\_\_\_\_ + \_\_\_\_\_ = \_\_\_\_\_ or \_\_\_\_\_ + \_\_\_\_\_ = \_\_\_\_\_

Teacher: \_\_\_\_\_  
Sign: \_\_\_\_\_  
Date: \_\_\_\_\_

2

Date: \_\_\_\_\_

Term 1



# Clever counting

## Counting the pumpkins

Find an easy way to count them.

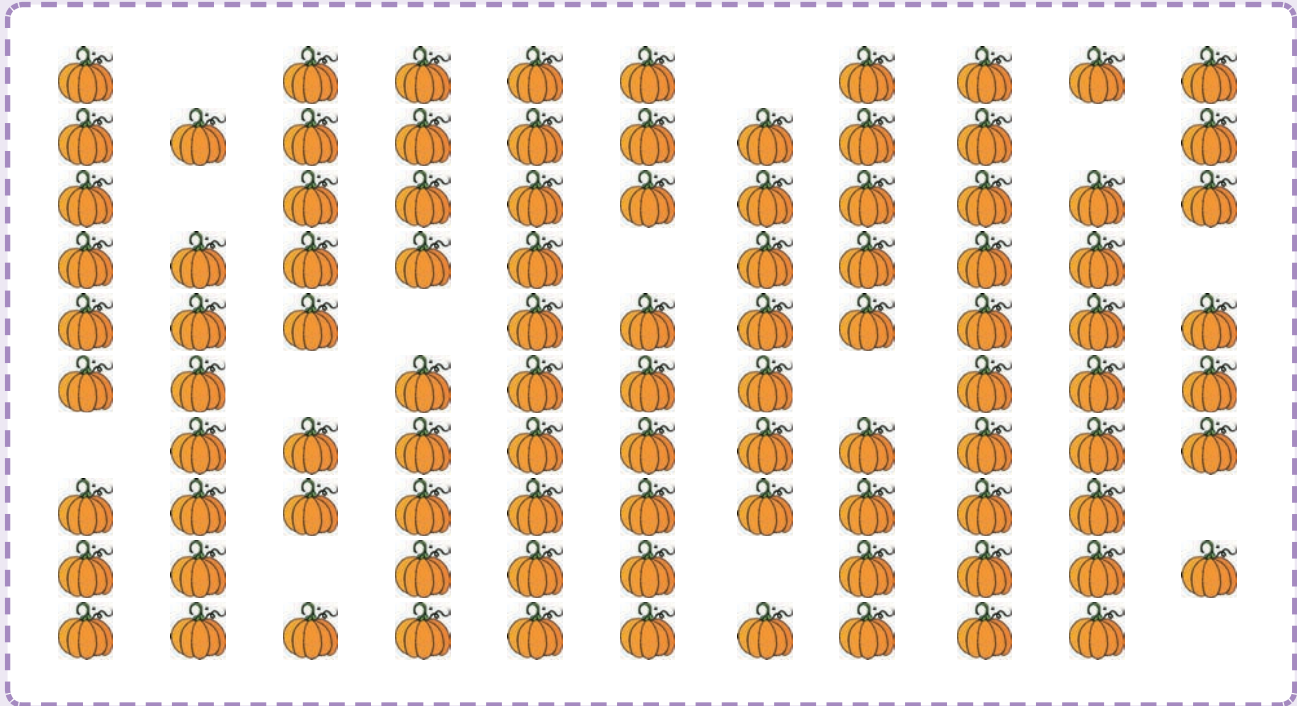

Answer: \_\_\_\_\_



## Packing the pumpkins

Ten pumpkins go in one bag.



How many bags can you fill with the pumpkins? \_\_\_\_\_

How many pumpkins are left over? \_\_\_\_\_

How many more pumpkins are needed to fill one more bag? \_\_\_\_\_



From + to  $\times$  (addition to multiplication)

Complete the number sentences.

Example:

$$10 + 10 + 10 + 10 = 40 \Rightarrow 4 \text{ groups of } 10 = 40 \Rightarrow 4 \times 10 = 40$$



a.  $10 + 10 + 10 = \underline{\hspace{2cm}}$

$\underline{\hspace{2cm}}$  groups of 10 =  $\underline{\hspace{2cm}}$   $\Rightarrow$   $\underline{\hspace{2cm}} \times \underline{\hspace{2cm}} = \underline{\hspace{2cm}}$



b.  $10 + 10 + 10 + 10 + 10 + 10 + 10 + 10 = \underline{\hspace{2cm}}$

$\underline{\hspace{2cm}}$  groups of 10 =  $\underline{\hspace{2cm}}$   $\Rightarrow$   $\underline{\hspace{2cm}} \times \underline{\hspace{2cm}} = \underline{\hspace{2cm}}$



Hands and fingers

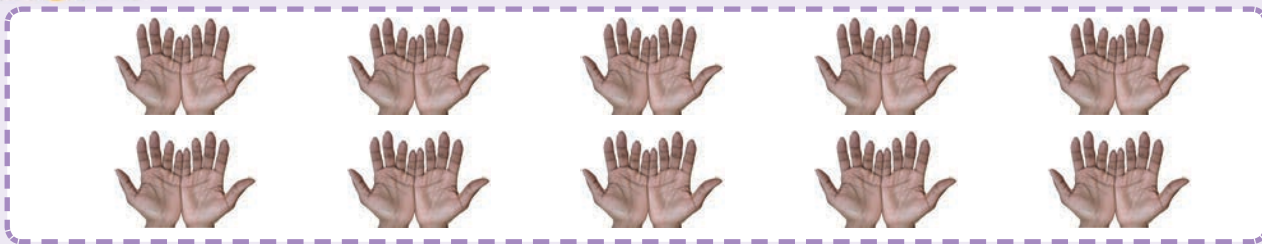

How many hands?  $\underline{\hspace{2cm}}$

How many fingers?  $\underline{\hspace{2cm}}$

Write your answer in 2 ways.

$\underline{\hspace{2cm}}$  groups of 10 =  $\underline{\hspace{2cm}}$  and  $\underline{\hspace{2cm}} \times 10 = \underline{\hspace{2cm}}$



Teacher: \_\_\_\_\_  
 Sign: \_\_\_\_\_  
 Date: \_\_\_\_\_

Date: \_\_\_\_\_

3a

# Numbers on a hundred board

Term 1



## Talking numbers

Count and say all the numbers from 1 to 100. Point as you go.

1	2	3	4	5	6		8	9	10
11									
						27			
			34						40
41									
				55					
		63							
71									
					86				
			94						100



- Write the missing number in each blue block.
- Write in the other numbers.
- What kind of numbers are the yellow numbers?



Write the numbers in words.

90	ninety	41	
77		56	
14		65	







## Counting and colouring

Get ready to count a colour!

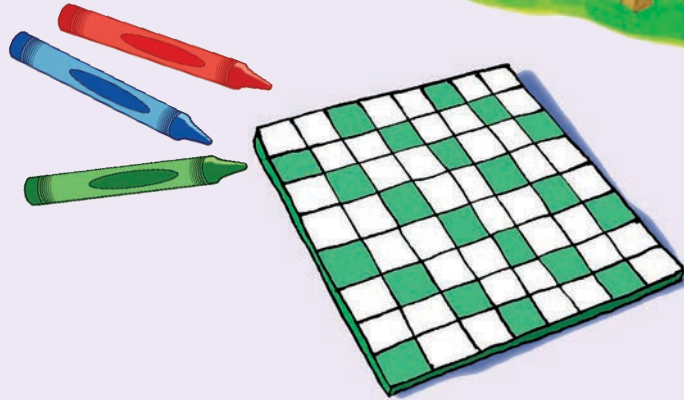

1	2	3	4	5	6	7	8	9	10
11	12	13	14	15	16	17	18	19	20
21	22	23	24	25	26	27	28	29	30
31	32	33	34	35	36	37	38	39	40
41	42	43	44	45	46	47	48	49	50
51	52	53	54	55	56	57	58	59	60
61	62	63	64	65	66	67	68	69	70
71	72	73	74	75	76	77	78	79	80
81	82	83	84	85	86	87	88	89	90
91	92	93	94	95	96	97	98	99	100

Count and colour the 10s.

Count in 10s from 10 to 100.

Write the 10s from 10 to 100.

1	2	3	4	5	6	7	8	9	10
11	12	13	14	15	16	17	18	19	20
21	22	23	24	25	26	27	28	29	30
31	32	33	34	35	36	37	38	39	40
41	42	43	44	45	46	47	48	49	50
51	52	53	54	55	56	57	58	59	60
61	62	63	64	65	66	67	68	69	70
71	72	73	74	75	76	77	78	79	80
81	82	83	84	85	86	87	88	89	90
91	92	93	94	95	96	97	98	99	100

Count and colour the 5s from 0 to 100.

Count in 5s from 5 to 100.

Write the 5s from 5 to 80.

1	2	3	4	5	6	7	8	9	10
11	12	13	14	15	16	17	18	19	20
21	22	23	24	25	26	27	28	29	30
31	32	33	34	35	36	37	38	39	40
41	42	43	44	45	46	47	48	49	50
51	52	53	54	55	56	57	58	59	60
61	62	63	64	65	66	67	68	69	70
71	72	73	74	75	76	77	78	79	80
81	82	83	84	85	86	87	88	89	90
91	92	93	94	95	96	97	98	99	100

Count and colour the 2s.

Count in 2s from 2 to 100.

Write the 2s from 2 to 100.



Teacher: \_\_\_\_\_  
 Sign: \_\_\_\_\_  
 Date: \_\_\_\_\_

11 12 13 14 15 16 17 18 19 20

3b

Date: \_\_\_\_\_

# Numbers on a hundred board (continued)

Term 1



Looking for patterns

1	2	3	4	5	6	7	8	9	10
11	12	13	14	15	16	17	18	19	20
21	22	23	24	25	26	27	28	29	30
31	32	33	34	35	36	37	38	39	40
41	42	43	44	45	46	47	48	49	50
51	52	53	54	55	56	57	58	59	60
61	62	63	64	65	66	67	68	69	70
71	72	73	74	75	76	77	78	79	80
81	82	83	84	85	86	87	88	89	90
91	92	93	94	95	96	97	98	99	100

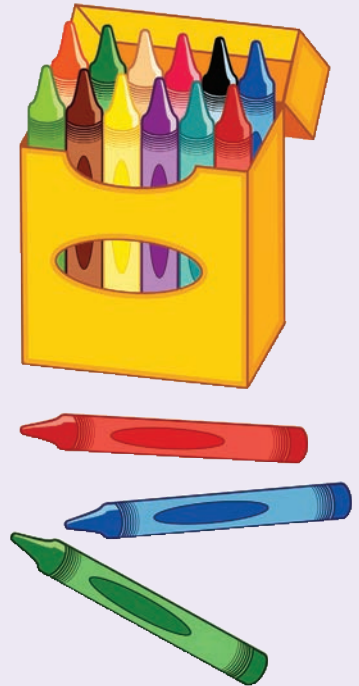

Tick (✓) all the 10s

Cross (X) the 5s

Circle (O) the 2s

Write the numbers that are in both the 2s and the 5s pattern.

---



---



---



---



---

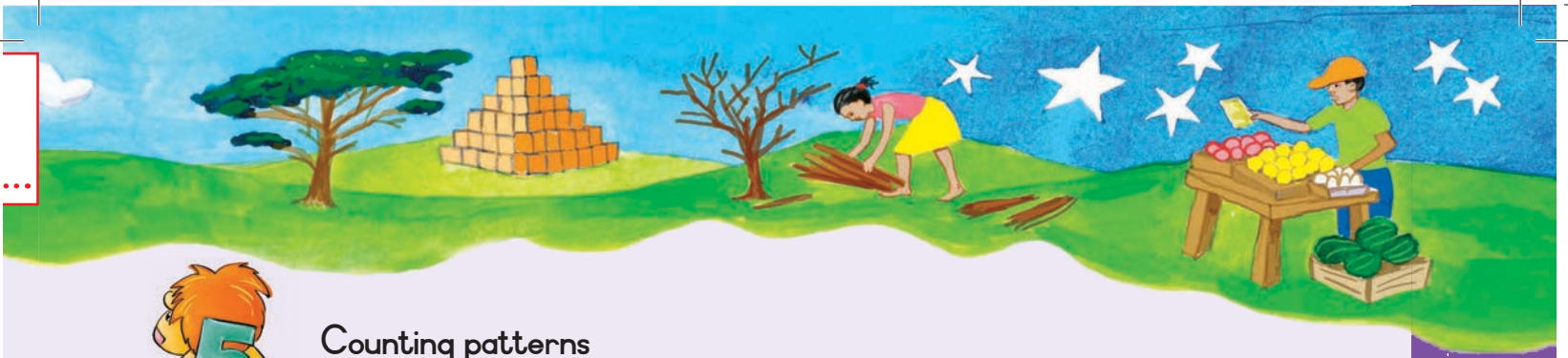

## Counting patterns

Fill in the missing numbers.

0; 10; 20; \_\_\_\_\_; \_\_\_\_\_; 50; \_\_\_\_\_; \_\_\_\_\_; 80; \_\_\_\_\_; 100; \_\_\_\_\_;  
 \_\_\_\_\_; 130; \_\_\_\_\_; \_\_\_\_\_; 160; \_\_\_\_\_; \_\_\_\_\_; \_\_\_\_\_; 200

0; 5; 10; \_\_\_\_\_; \_\_\_\_\_; 25; \_\_\_\_\_; \_\_\_\_\_; 40; \_\_\_\_\_; 50; 55; \_\_\_\_\_;  
 \_\_\_\_\_; 70; \_\_\_\_\_; \_\_\_\_\_; 85; \_\_\_\_\_; \_\_\_\_\_; 100

0; 2; 4; 6; \_\_\_\_\_; \_\_\_\_\_; 12; \_\_\_\_\_; \_\_\_\_\_; 18; \_\_\_\_\_; 22; 24; \_\_\_\_\_;  
 \_\_\_\_\_; 30; \_\_\_\_\_; \_\_\_\_\_; 36; 38; \_\_\_\_\_; \_\_\_\_\_; \_\_\_\_\_; 46; \_\_\_\_\_;

0; \_\_\_\_\_; 8; \_\_\_\_\_; 16; 20; \_\_\_\_\_; 28; \_\_\_\_\_; 36; \_\_\_\_\_; \_\_\_\_\_;  
 \_\_\_\_\_; 52; \_\_\_\_\_; \_\_\_\_\_; 64; \_\_\_\_\_; 72; \_\_\_\_\_; 80

0; \_\_\_\_\_; 10; \_\_\_\_\_; 20; \_\_\_\_\_; 30; \_\_\_\_\_; 40; \_\_\_\_\_; \_\_\_\_\_; 55;  
 60; \_\_\_\_\_; 70; 75; \_\_\_\_\_; 85; \_\_\_\_\_; \_\_\_\_\_; 100

0; 3; \_\_\_\_\_; 9; \_\_\_\_\_; 15; 18; \_\_\_\_\_; 24; \_\_\_\_\_; \_\_\_\_\_; 33; \_\_\_\_\_; 39;  
 \_\_\_\_\_; 45; \_\_\_\_\_; \_\_\_\_\_; 54; 57; \_\_\_\_\_; 63; \_\_\_\_\_; \_\_\_\_\_; 72; 75



Teacher: \_\_\_\_\_  
 Sign: \_\_\_\_\_  
 Date: \_\_\_\_\_

Date: \_\_\_\_\_



# Place value

Term 1





## Showing your numbers

Cut out the number cards from Cut-out sheet 1.  
Use the cards to build these numbers.

19      43      69      54      35      10      9

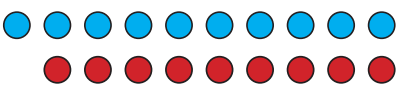

19                   $10 + 9 = 19$

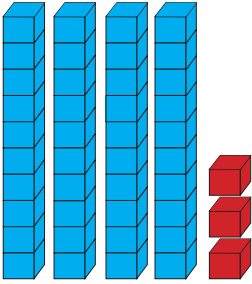
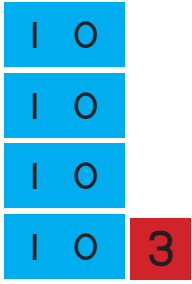
43                   $40 + 3 = 43$

Now do it yourself for these numbers using Cut-out 1.

54

35

69



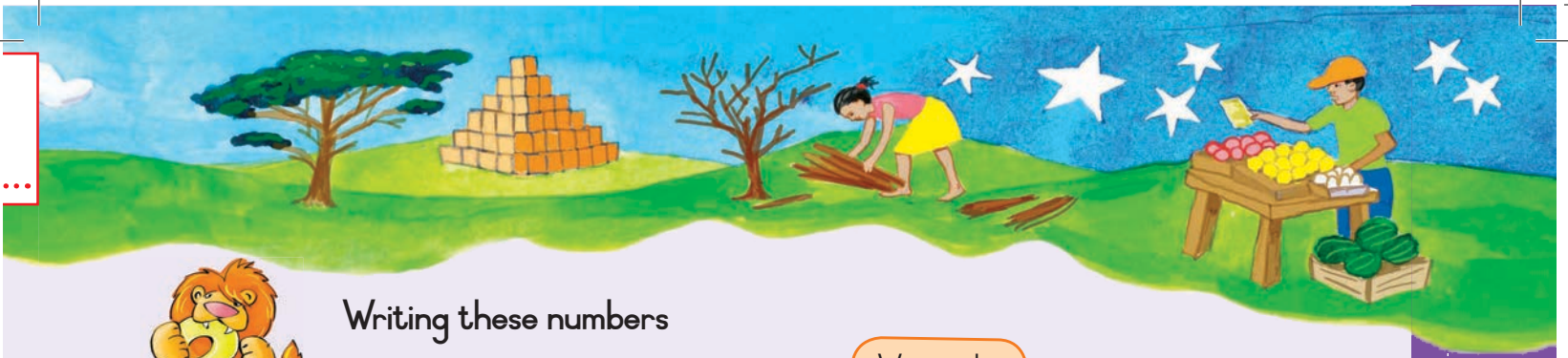

### Writing these numbers

We have done the first one for you.

We can also say 9 ones.

19	$10 + 9$	1 ten + 9 units	nineteen
43			
69			
54			
35			
21			
73			
44			
32			
89			
17			
95			
56			
68			
67			



Write the first five numbers, in the table above, in order from smallest to biggest.

\_\_\_\_\_ ; \_\_\_\_\_ ; \_\_\_\_\_ ; \_\_\_\_\_ ; \_\_\_\_\_



Teacher: \_\_\_\_\_  
Sign: \_\_\_\_\_  
Date: \_\_\_\_\_

## Addition and subtraction



## Lebo's stall

In the morning Lebo has 19 packets of apples.  
By lunchtime she has 13 packets left.



a. How many packets does Lebo sell? \_\_\_\_\_

b. Write your answer as a number sentence.

\_\_\_\_\_ - \_\_\_\_\_ = \_\_\_\_\_

Write five other numbers sentences to show the same answer.

$15 - 9 = 6$  \_\_\_\_\_



## Number drill

Write the answers.

$$1 + 2 = 3$$



$10 + 5 = \square$	$11 + 6 = \square$	$14 - 9 = \square$	$14 - 8 = \square$
$11 + 5 = \square$	$17 + 2 = \square$	$19 - 7 = \square$	$14 - 5 = \square$
$12 + 6 = \square$	$3 + 13 = \square$	$16 - 5 = \square$	$16 - 13 = \square$
$17 + 2 = \square$	$4 + 15 = \square$	$15 - 10 = \square$	$19 - 7 = \square$



## Number families

5

9

14

Here are examples of this number family.

$9 + 5 = 14$	$5 + 9 = 14$
$14 - 9 = 5$	$14 - 5 = 9$

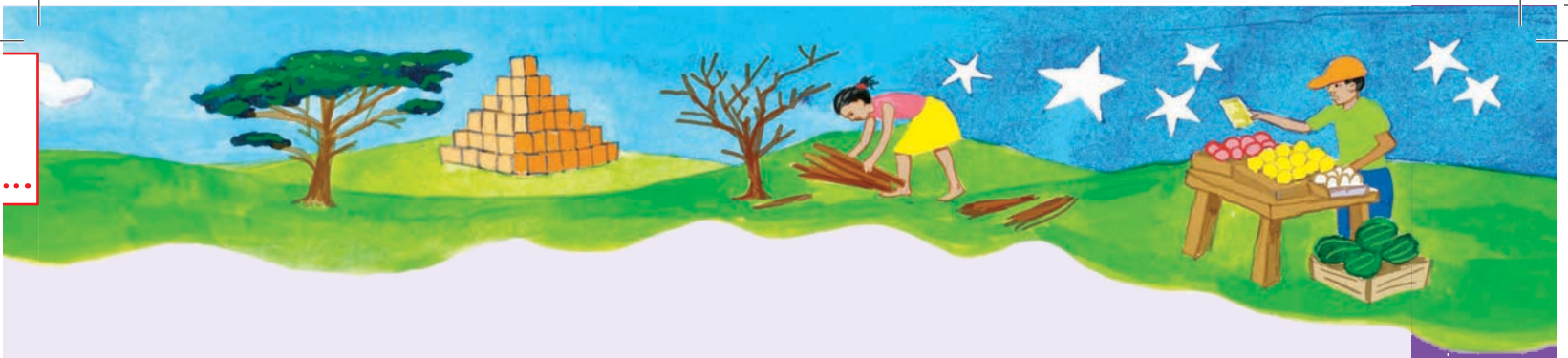

Can you find all the number families of 14?

$1 + 13 = 14$	$13 + 1 = 14$	$14 - 1 = 13$	$14 - 13 = 1$
$2 + 12 =$			
$3 + 11 =$			
$4 + 10 =$			
$5 + 9 =$			
$6 + 8 =$			
$7 + 7 =$			



I am going to do the same with 12.

12

$1 + 11 = 12$			
$2 + 10 = 12$			
$3 + 9 = 12$			
$4 + 8 = 12$			
$5 + 7 = 12$			
$6 + 6 = 12$			



Teacher: \_\_\_\_\_  
 Sign: \_\_\_\_\_  
 Date: \_\_\_\_\_

11 12 13 14 15 16 17 18 19 20

Date: \_\_\_\_\_

6

# Doubles and halves

Term 1

Do you remember?  
Double 2 is 4      Double 20 is 40      4 is double 2      40 is double 20

We can show this in a drawing ...

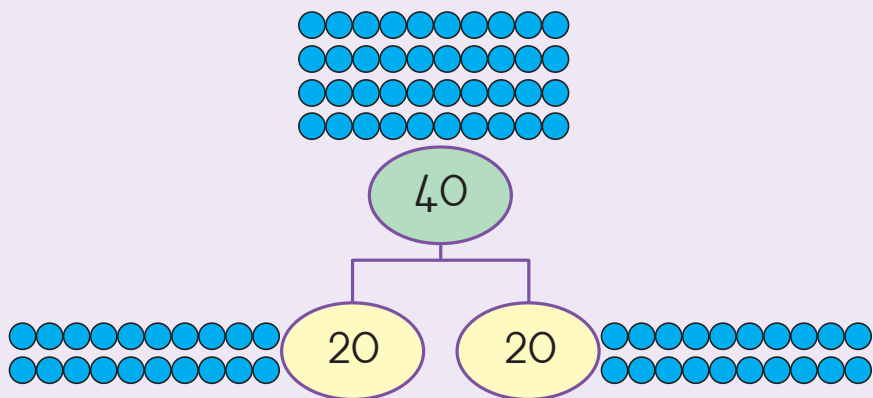
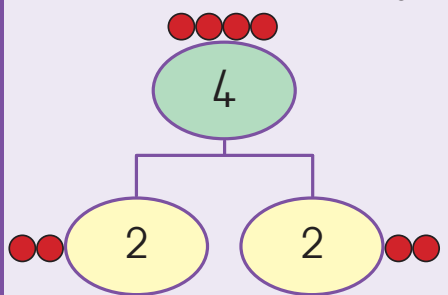

## Finding doubles or halves

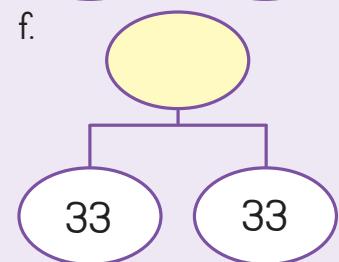
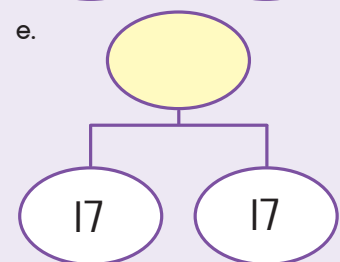
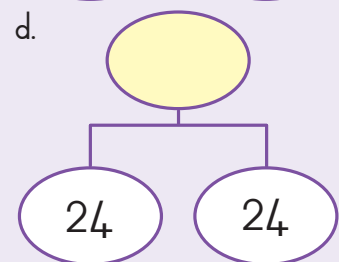
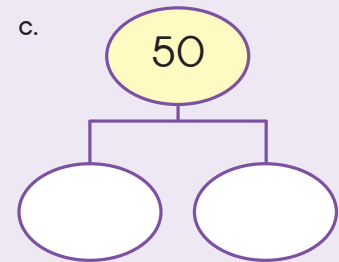
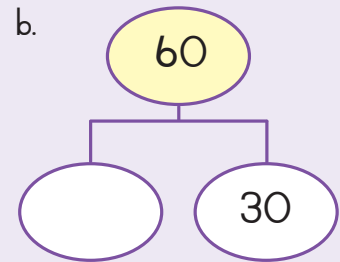
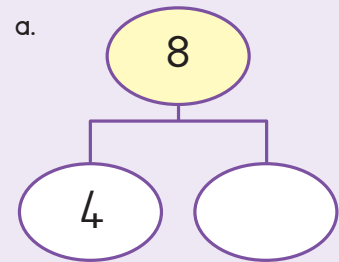

## Challenge

Find one half of 3.

Show as a number or number name. A drawing might help you.



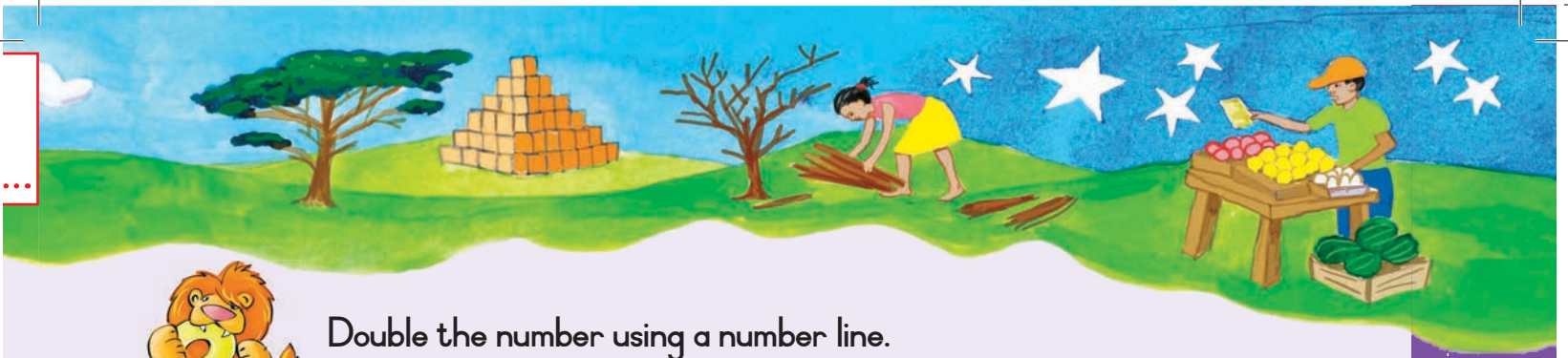

Double the number using a number line.  
The first example is given to you.

a. Double 4     $\boxed{4} + \boxed{4} = \boxed{8}$

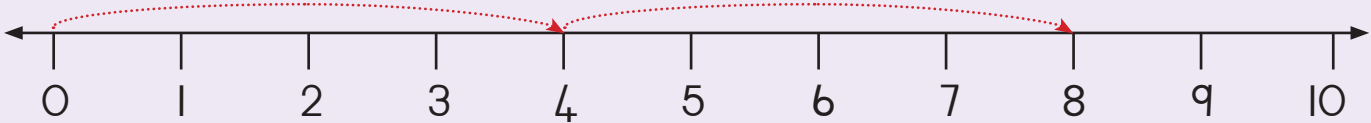

b. Double 5     $\boxed{\phantom{0}} + \boxed{\phantom{0}} = \boxed{\phantom{0}}$



c. Double 20     $\boxed{\phantom{00}} + \boxed{\phantom{00}} = \boxed{\phantom{00}}$

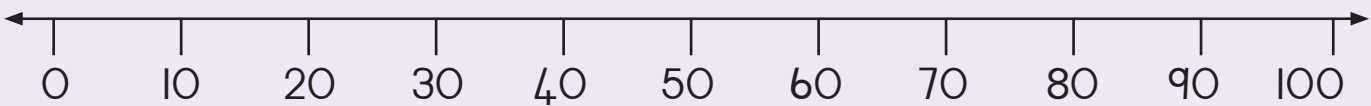

d. Double 40     $\boxed{\phantom{00}} + \boxed{\phantom{00}} = \boxed{\phantom{00}}$

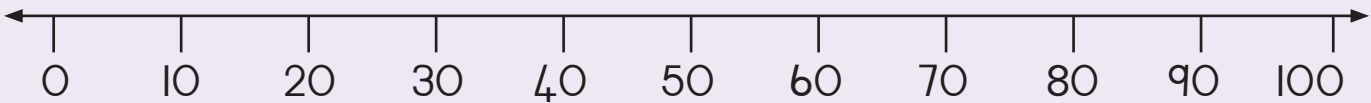

Complete the following

a. Double 1	2
b. Double 6	
c. Double 10	
d. Double 30	
e. Double 50	



Complete the following

a. Half 6	3
b. Half 8	
c. Half 14	
d. Half 60	
e. Half 70	



Teacher: \_\_\_\_\_

Sign: \_\_\_\_\_

Date: \_\_\_\_\_

## Fractions

Colour one quarter of the balloons red and the rest blue.

Colour one half of each box red.

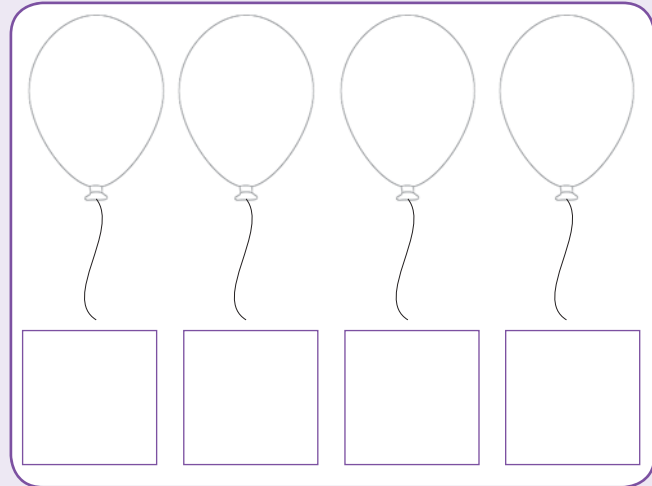

Look at the shapes. Tick the shapes that show halves.

Colour one half of each shape that is divided into halves.

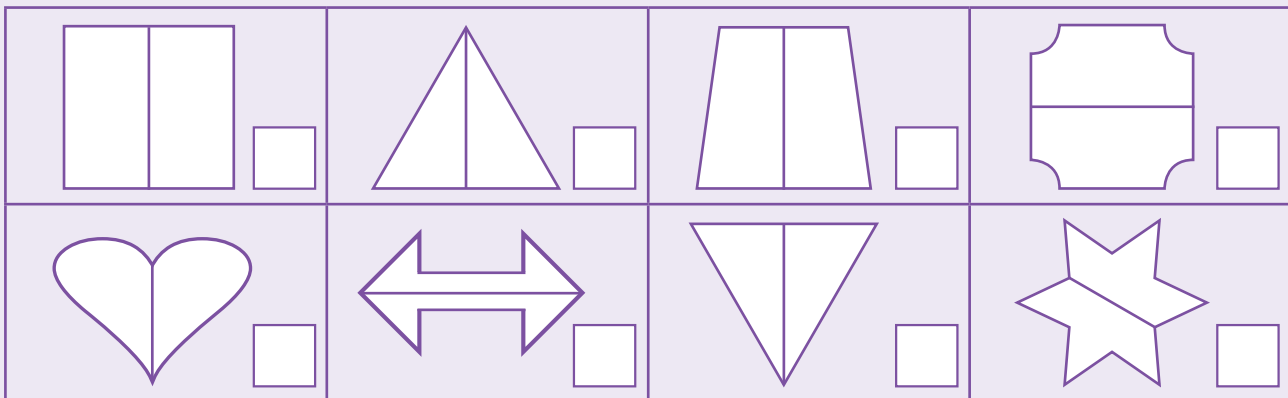

Look at the shapes. Tick the shapes that show quarters.

Colour one quarter of each shape that is exactly divided into equal quarters.

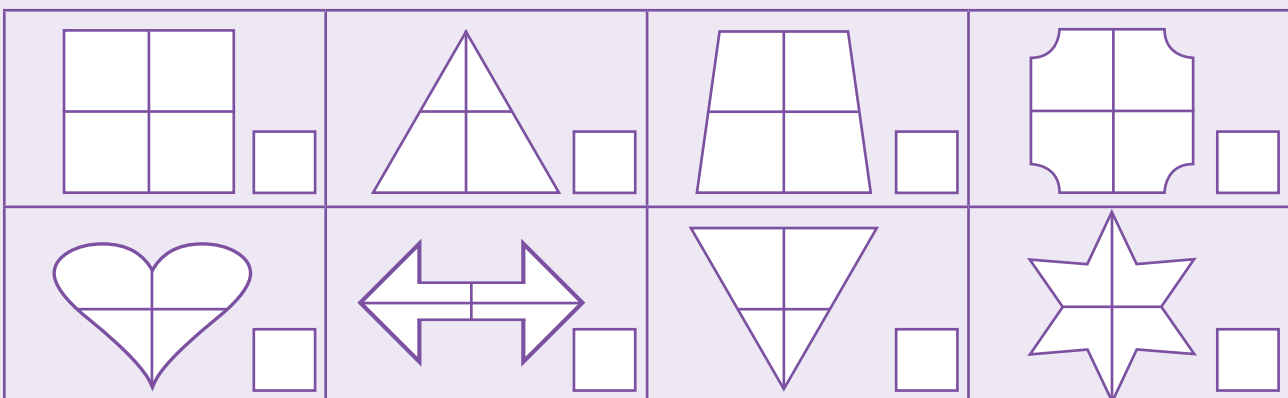

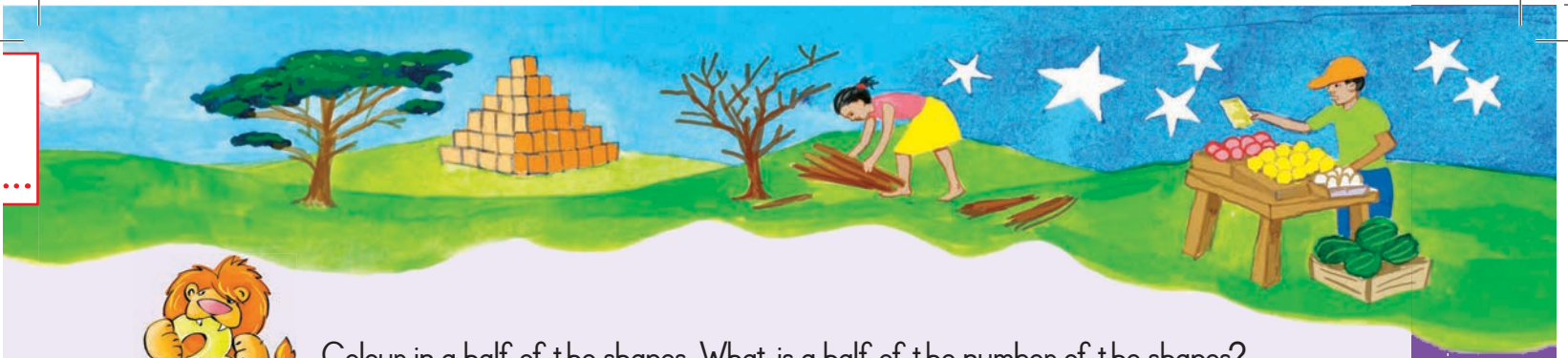

Colour in a half of the shapes. What is a half of the number of the shapes?

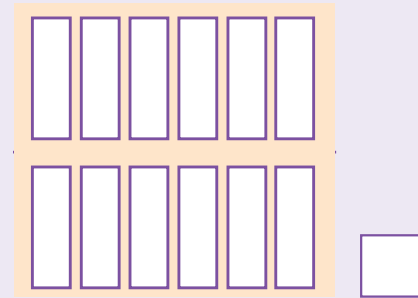
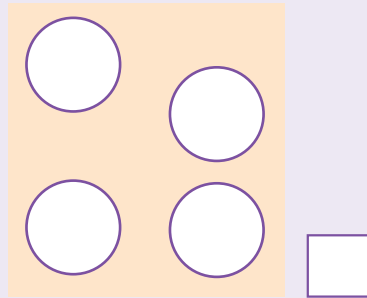
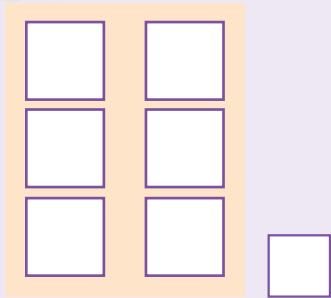

Colour in a quarter of the shapes. What is a quarter of the number of the shapes?

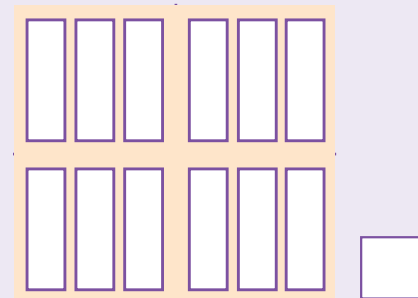
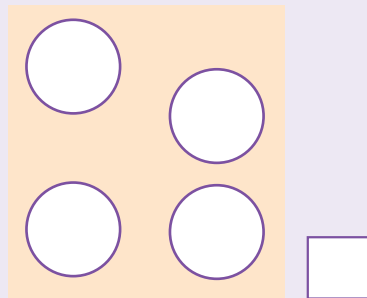
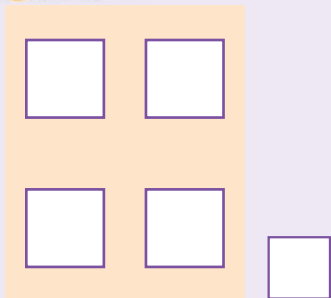

Write as a fraction symbol.

one half



one quarter



Draw more shapes to make each half equal.

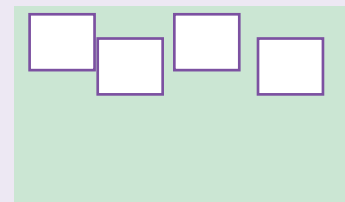
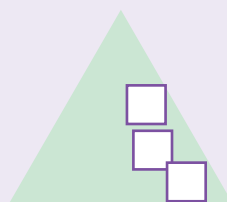
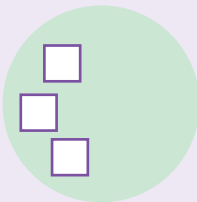

Draw more shapes to make each quarter equal.

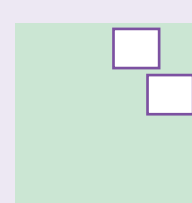
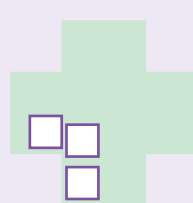
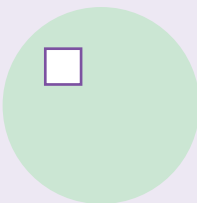

Teacher: \_\_\_\_\_  
 Sign: \_\_\_\_\_  
 Date: \_\_\_\_\_

Date: \_\_\_\_\_

# Sorting money



## At the stokvel

Ma Lubisi counts and sorts the money from the group.



















Estimate the total amount. R \_\_\_\_\_

Count the money. R \_\_\_\_\_

Compare estimates and totals.



## Saving money

Gugu saves for a pair of shoes that costs R89.  
 So far she has half the amount.  
 How much more does she need?  
 Write a number sentence to show your answer.





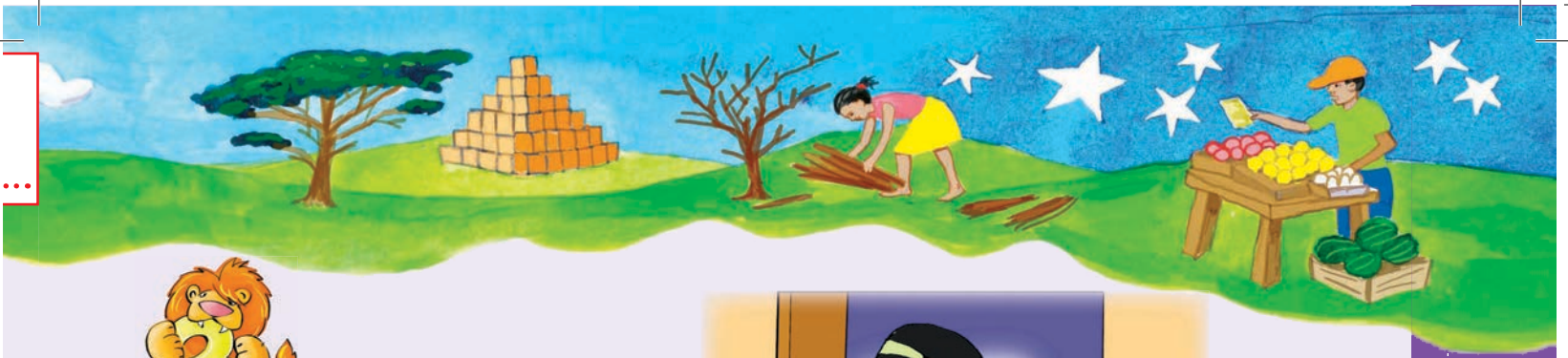







\_\_\_\_\_



### At the bank

Maria sorts the notes into piles of 5.  
 She also has some notes left over.  
 Write the totals for each row of pictures.



			Amount	
			R _____	
				R _____
			R _____	



### Challenge

#### A visit to the zoo

Some adults and children go to the zoo.  
 They buy tickets for R90.

How many are children? \_\_\_\_\_

How many are adults? \_\_\_\_\_

Is there another answer?

Adults \_\_\_\_\_ Children \_\_\_\_\_

Teacher: \_\_\_\_\_  
 Sign: \_\_\_\_\_  
 Date: \_\_\_\_\_

9

Date: \_\_\_\_\_

## Patterns

Term 1



Use this 200 number board to answer the questions.

1	2	3	4	5	6	7	8	9	10
11	12	13	14	15	16	17	18	19	20
21	22	23	24	25	26	27	28	29	30
31	32	33	34	35	36	37	38	39	40
41	42	43	44	45	46	47	48	49	50
51	52	53	54	55	56	57	58	59	60
61	62	63	64	65	66	67	68	69	70
71	72	73	74	75	76	77	78	79	80
81	82	83	84	85	86	87	88	89	90
91	92	93	94	95	96	97	98	99	100
101	102	103	104	105	106	107	108	109	110
111	112	113	114	115	116	117	118	119	120
121	122	123	124	125	126	127	128	129	130
131	132	133	134	135	136	137	138	139	140
141	142	143	144	145	146	147	148	149	150
151	152	153	154	155	156	157	158	159	160
161	162	163	164	165	166	167	168	169	170
171	172	173	174	175	176	177	178	179	180
181	182	183	184	185	186	187	188	189	190
191	192	193	194	195	196	197	198	199	200



Use the 200 number board to complete the next four numbers in these number patterns. Then colour the pattern on the number board.

105, 110, 115, _____, _____, _____	87, 90, 93, _____, _____, _____
36, 40, 44, _____, _____, _____	184, 186, 188, _____, _____, _____
70, 65, 60, _____, _____, _____	138, 135, 132, _____, _____, _____
180, 176, 172, _____, _____, _____	14, 12, 10, _____, _____, _____



Write the numbers that come next in each pattern. Then colour in the pattern.  
 What do you notice about the numbers shaded with the same colour?

Counting in fives.

			5				10

Counting in twos.

	2		4				

Counting in threes.

		3			6		

Counting in tens.

									10



Extend the pattern.

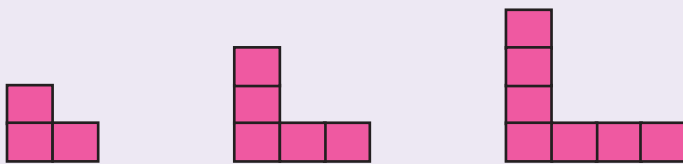

Teacher: \_\_\_\_\_

Sign: \_\_\_\_\_

Date: \_\_\_\_\_

11 12 13 14 15 16 17 18 19 20

10

Date: \_\_\_\_\_

# Balls, boxes and cylinders

Term 1



Circle the boxes in blue, the balls in red and the cylinders in green.



Colour the correct answer.

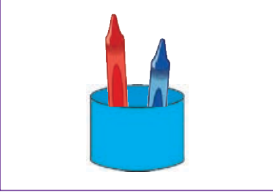

The box  
slides    rolls

The cylinder  
slides    rolls

The ball  
slides    rolls



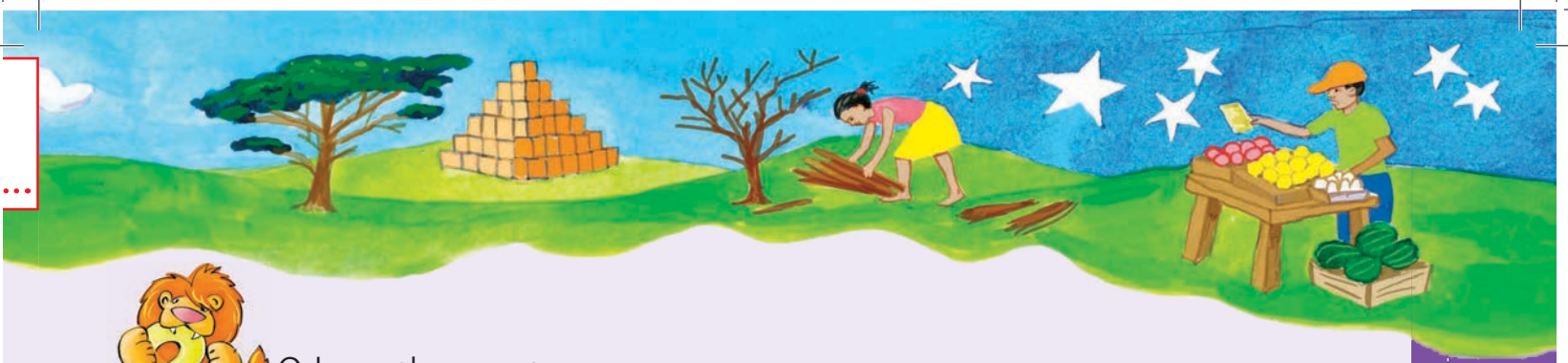

Colour in the correct answer.



curved edge

straight edge



curved edge

straight edge



curved edge

straight edge



curved edge

straight edge

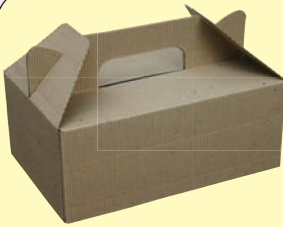

curved edge

straight edge



curved edge

straight edge



curved edge

straight edge



curved edge

straight edge



Say if the can is behind, in front of, next to or on top of the box.



behind

in front of

next to

on top of



behind

in front of

next to

on top of



behind

in front of

next to

on top of



behind

in front of

next to

on top of



Teacher: \_\_\_\_\_

Sign: \_\_\_\_\_

Date: \_\_\_\_\_

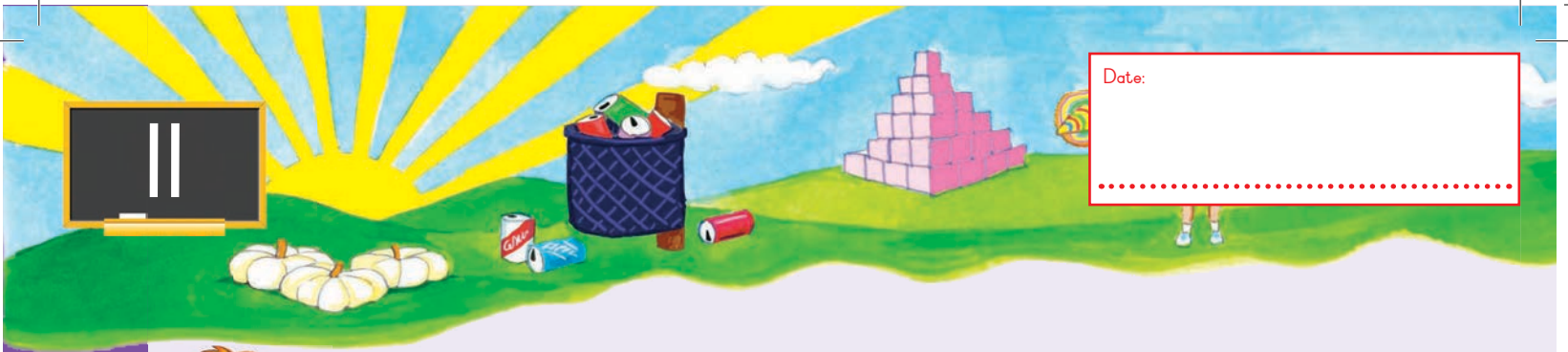

Date: \_\_\_\_\_

Term 1



## Draw, name and compare 2D shapes

Draw the shapes.

Triangle

Circle

Square

Rectangle



## Counting the shapes.

Count how many shapes like this you can find in the picture.

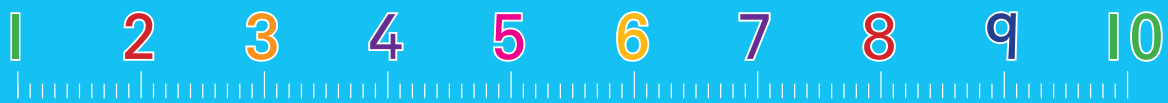

Colour all the





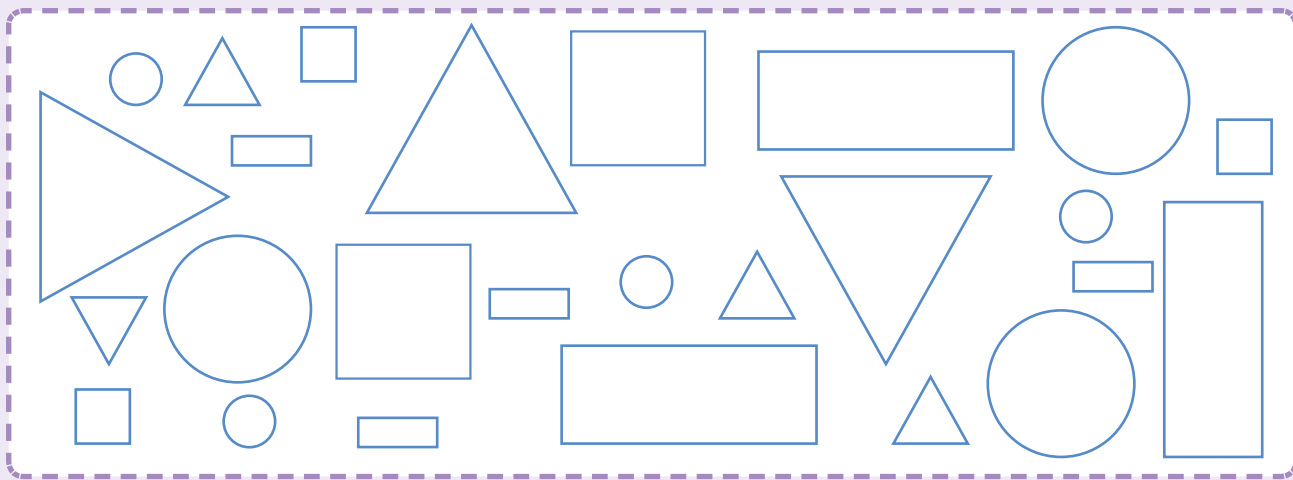

- big circles red, small circles green;
- big triangles blue, small triangles orange;
- big squares yellow, small squares purple;
- big rectangles brown, small rectangles pink.

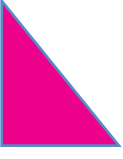

How many sides?

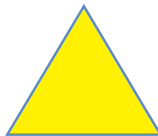
How many sides does each shape have? Write the number in the block.

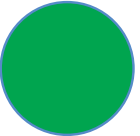
We have done one for you. Are the sides straight or curved? Colour in the correct answer.

 <div style="display: flex; justify-content: space-around;"> <div style="border: 1px solid black; padding: 2px;">3</div> </div> <div style="display: flex; justify-content: space-around; margin-top: 5px;"> <span style="border: 1px solid black; padding: 2px;">straight</span> <span style="border: 1px solid black; padding: 2px;">curved</span> </div>	 <div style="display: flex; justify-content: space-around;"> <div style="border: 1px solid black; width: 30px; height: 30px;"></div> </div> <div style="display: flex; justify-content: space-around; margin-top: 5px;"> <span style="border: 1px solid black; padding: 2px;">straight</span> <span style="border: 1px solid black; padding: 2px;">curved</span> </div>	 <div style="display: flex; justify-content: space-around;"> <div style="border: 1px solid black; width: 30px; height: 30px;"></div> </div> <div style="display: flex; justify-content: space-around; margin-top: 5px;"> <span style="border: 1px solid black; padding: 2px;">straight</span> <span style="border: 1px solid black; padding: 2px;">curved</span> </div>	 <div style="display: flex; justify-content: space-around;"> <div style="border: 1px solid black; width: 30px; height: 30px;"></div> </div> <div style="display: flex; justify-content: space-around; margin-top: 5px;"> <span style="border: 1px solid black; padding: 2px;">straight</span> <span style="border: 1px solid black; padding: 2px;">curved</span> </div>
 <div style="display: flex; justify-content: space-around;"> <div style="border: 1px solid black; width: 30px; height: 30px;"></div> </div> <div style="display: flex; justify-content: space-around; margin-top: 5px;"> <span style="border: 1px solid black; padding: 2px;">straight</span> <span style="border: 1px solid black; padding: 2px;">curved</span> </div>	 <div style="display: flex; justify-content: space-around;"> <div style="border: 1px solid black; width: 30px; height: 30px;"></div> </div> <div style="display: flex; justify-content: space-around; margin-top: 5px;"> <span style="border: 1px solid black; padding: 2px;">straight</span> <span style="border: 1px solid black; padding: 2px;">curved</span> </div>	 <div style="display: flex; justify-content: space-around;"> <div style="border: 1px solid black; width: 30px; height: 30px;"></div> </div> <div style="display: flex; justify-content: space-around; margin-top: 5px;"> <span style="border: 1px solid black; padding: 2px;">straight</span> <span style="border: 1px solid black; padding: 2px;">curved</span> </div>	 <div style="display: flex; justify-content: space-around;"> <div style="border: 1px solid black; width: 30px; height: 30px;"></div> </div> <div style="display: flex; justify-content: space-around; margin-top: 5px;"> <span style="border: 1px solid black; padding: 2px;">straight</span> <span style="border: 1px solid black; padding: 2px;">curved</span> </div>



Teacher: \_\_\_\_\_

Sign: \_\_\_\_\_

Date: \_\_\_\_\_

Date: \_\_\_\_\_

## Time passes



### Reading the time

What times do these watches show?



\_\_\_\_\_ o'clock      \_\_\_\_\_ o'clock      \_\_\_\_\_ o'clock      \_\_\_\_\_ o'clock



### Jump around the clock

Help Minnie Mouse count the minutes in 5s.  
Start at the 12. Go all the way around.



How many minutes do you count? \_\_\_\_\_

How many minutes in 1 hour? \_\_\_\_\_



### Writing the time

Draw the hands to show the times.



quarter past 6



half past 8



quarter to 11



half past 5



Zander walks to school.



He leaves home.



He gets to school.

How long does Zander take? \_\_\_\_\_



### Baking day

Maria bakes bread.



The bread goes into the oven.



The bread comes out.



The bread bakes for \_\_\_\_\_ minutes.



### Challenge

I can see a pattern.

In double time

a. Change the hours to minutes.

Hours	1	2	4	8
Minutes	60			

b. Mandla takes 45 minutes to get to school. Zander takes twice as long. How many hours does Zander take to get to school?

\_\_\_\_\_



Teacher: \_\_\_\_\_  
 Sign: \_\_\_\_\_  
 Date: \_\_\_\_\_

# Measuring length

Term 1

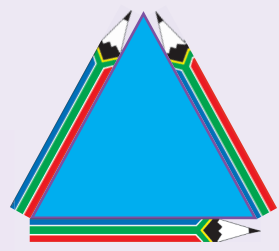

Together, all the sides of this triangle are 3 pencils long.

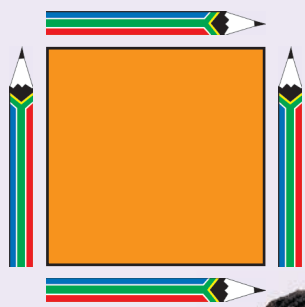

Together, all the sides of this square are 4 pencils long.

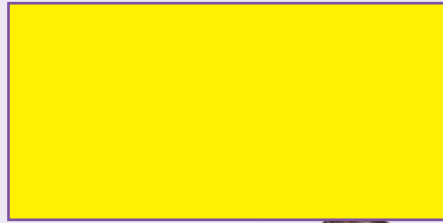

I wonder how long and wide the rectangle is.

How many pencils long is the rectangle?

How many pencils wide is the rectangle?

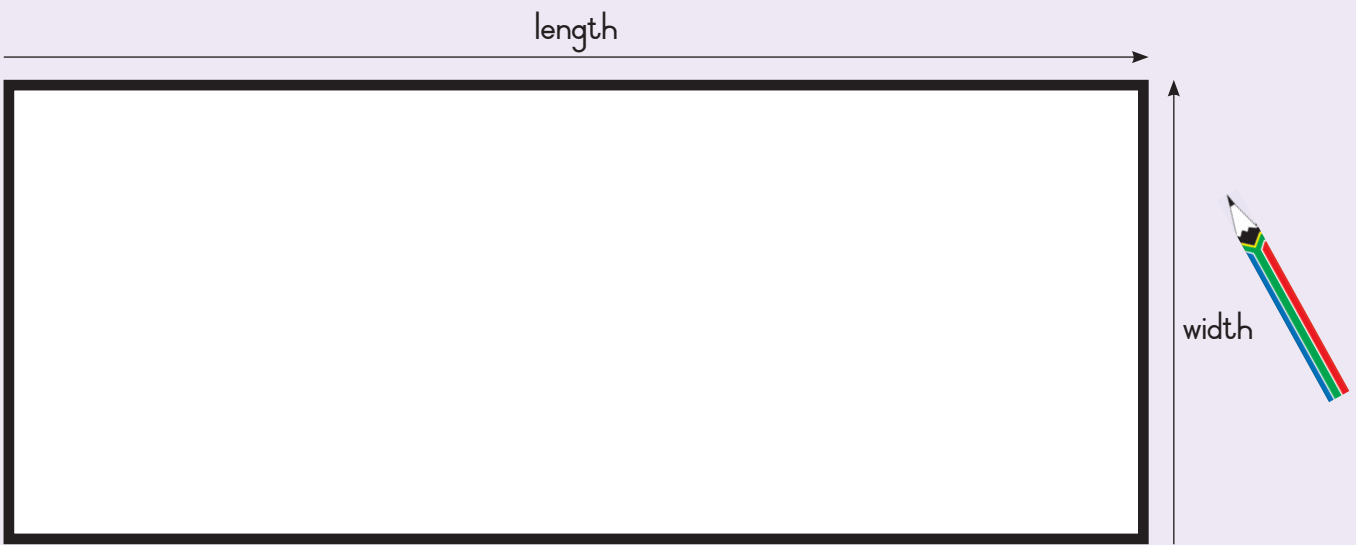

How did you use the pencils to count?



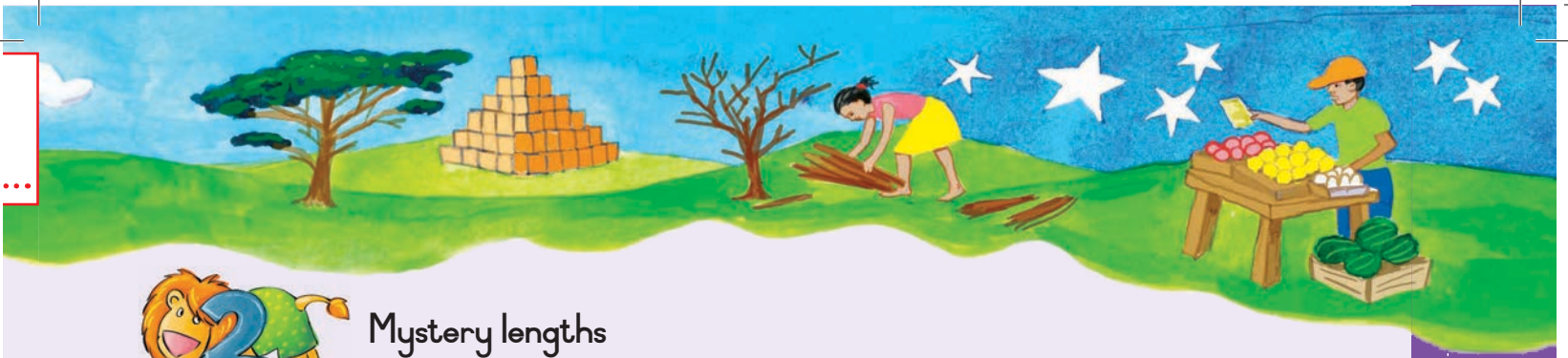

## Mystery lengths

a. How many of the red lines do you need to cover the black line?

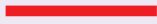

b. How many of the red lines do you need to go all the way around the rectangle?

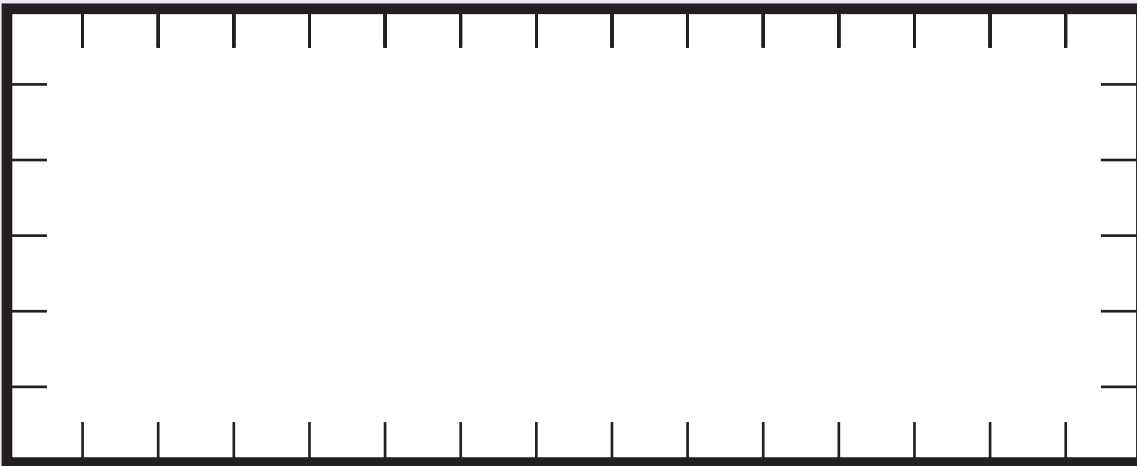

c. Which is longer, the top path or the lower one, or are they the same?

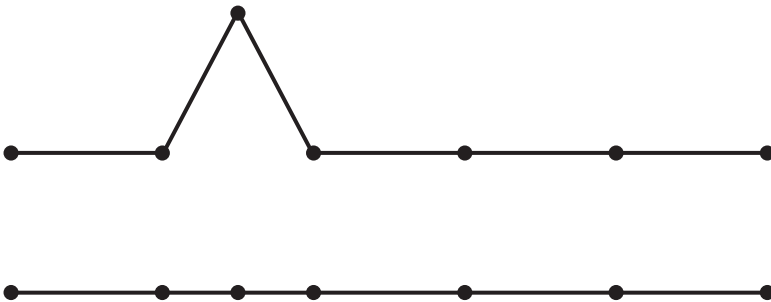

Answer \_\_\_\_\_

Why? \_\_\_\_\_



Teacher: \_\_\_\_\_

Sign: \_\_\_\_\_

Date: \_\_\_\_\_

Date: \_\_\_\_\_

14

# Capacity

Term 1



The measuring jug holds 10 cups of water. I have already put two cups into the measuring jug.

How many more cups of water will fill the container?

\_\_\_\_\_



How many cups of water are in the container?  
How many cups more do we need to fill the container?



In the container:  Need more:

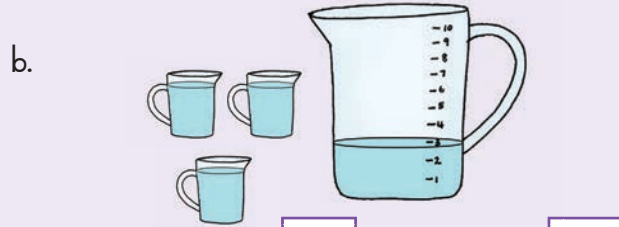

In the container:  Need more:

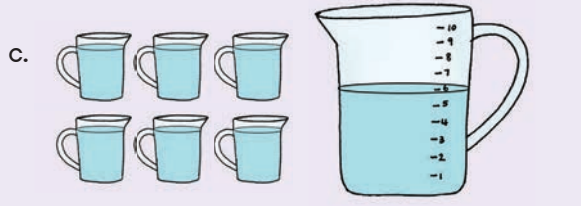

In the container:  Need more:

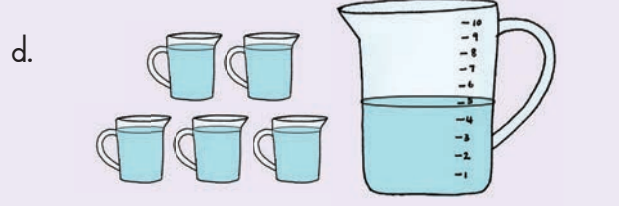

In the container:  Need more:



In the container:  Need more:

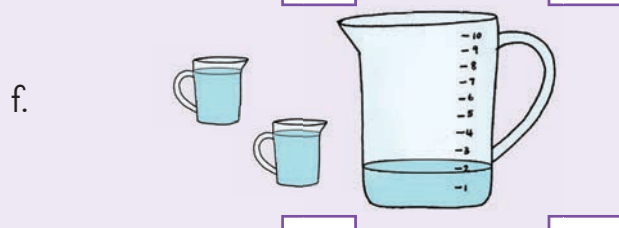

In the container:  Need more:



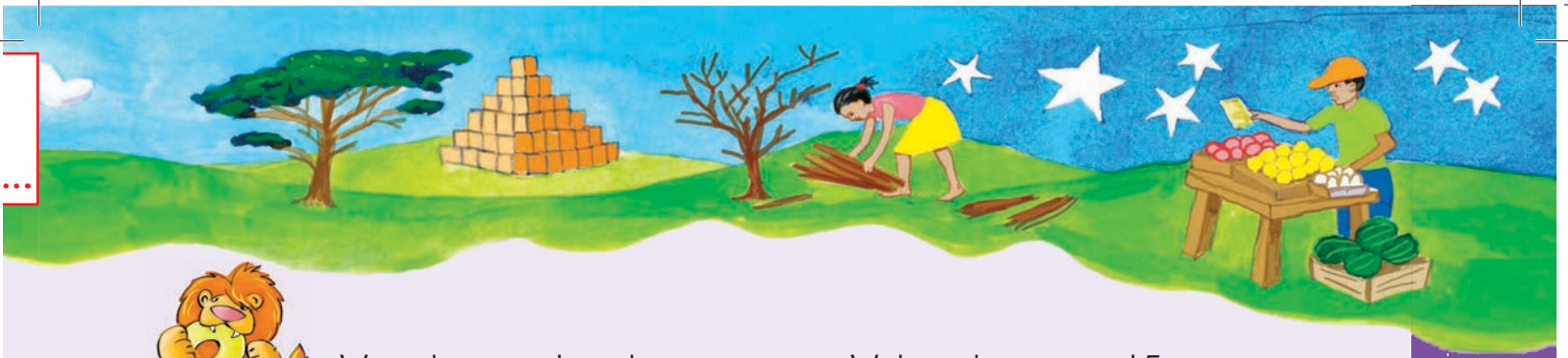

Write the intervals on this measuring jug. We have shown interval 5.

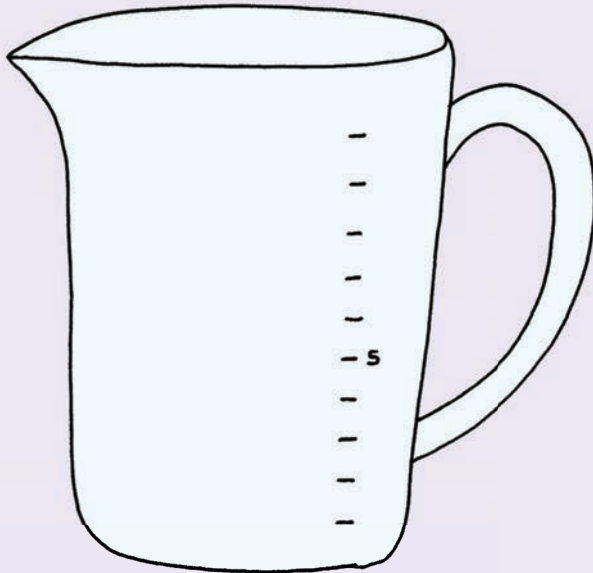

If one cup fills the jug to the second interval, how many cups do you need to fill the jug to:

- a. 4 \_\_\_\_\_
- b. 6 \_\_\_\_\_
- c. 8 \_\_\_\_\_
- d. 10 \_\_\_\_\_



Tick which containers you think hold 1 litre of liquid.











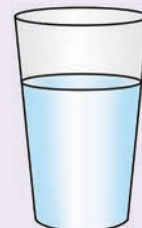



Teacher: \_\_\_\_\_

Sign: \_\_\_\_\_

Date: \_\_\_\_\_

## Working with mass



Let's measure how heavy we are!

To find out how **heavy** or **light** we are, we use a scale.

We use **kilograms** to measure how heavy we are.

We use this abbreviation: kg. Who weighs the most?

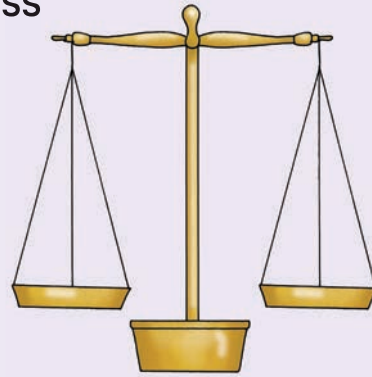

41 kg



38 kg



41 kg



42 kg



39 kg



We use a balance scale to measure mass.



On this scale both apples weigh the same.

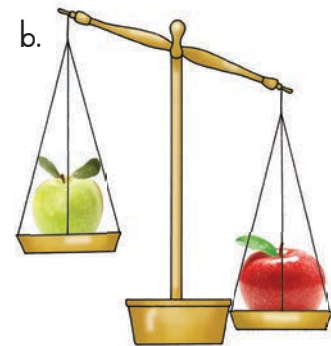
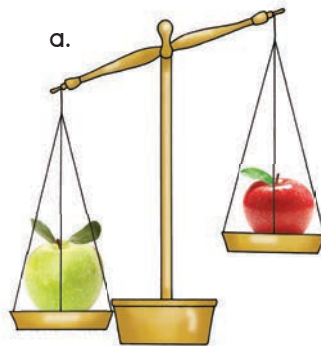

Answer the question. Write a or b.

On which scale is the green apple heavier than the red apple

On which scale is the green apple lighter than the red apple

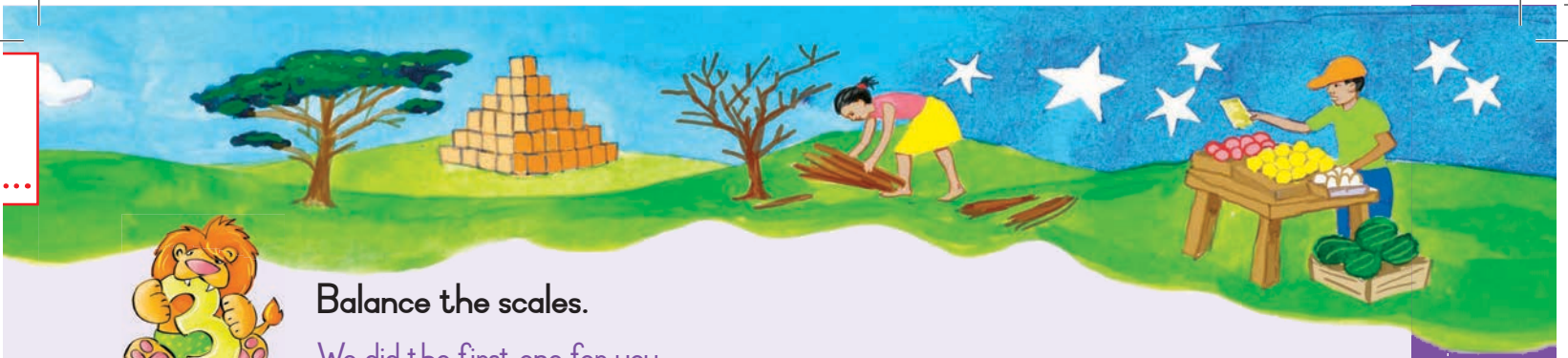

Balance the scales.

We did the first one for you.

Two bricks weigh the same as four balls.

Draw how many bricks or balls you need to make these scales balance.

a.

b.



If one parcel weighs 3 kg, how much will 2 and 3 parcels weigh?

- 2 parcels \_\_\_\_\_ kg
- 3 parcels \_\_\_\_\_ kg
- Can I measure 4 parcels at the same time on this kitchen scale? \_\_\_\_\_  
Why or why not? \_\_\_\_\_



Tick in the answer blocks which objects weigh about 1 kg.

Teacher: \_\_\_\_\_

Sign: \_\_\_\_\_

Date: \_\_\_\_\_



## Data handling

### Shoes in the class



Read the story.

Thabo: Wow, Miss! Jack is a giant! He wears size 6 shoes!

Mrs Khoza: Well! Yes, Thabo, that is big for a nine year old!  
What size shoe do you wear Thabo? What sizes do the rest of the class wear?  
Let's do a survey!

The learners call out their sizes, one by one.

Mrs Khoza writes the sizes on the board.

Mrs Khoza: Count, then write how many of each size.

2	2	3	1	2	3	1	4	3	2	3
2	3	2	6	2	2	3	3	3	4	3
4	2	2	3	3	5	3	2	2	2	1
1	1	2	4	2	3	2	3	4	2	4
4	3	2	2	3	1	2	2	1	4	3

Fill in the table below.

Shoe sizes in the class					
Size 1	Size 2	Size 3	Size 4	Size 5	Size 6

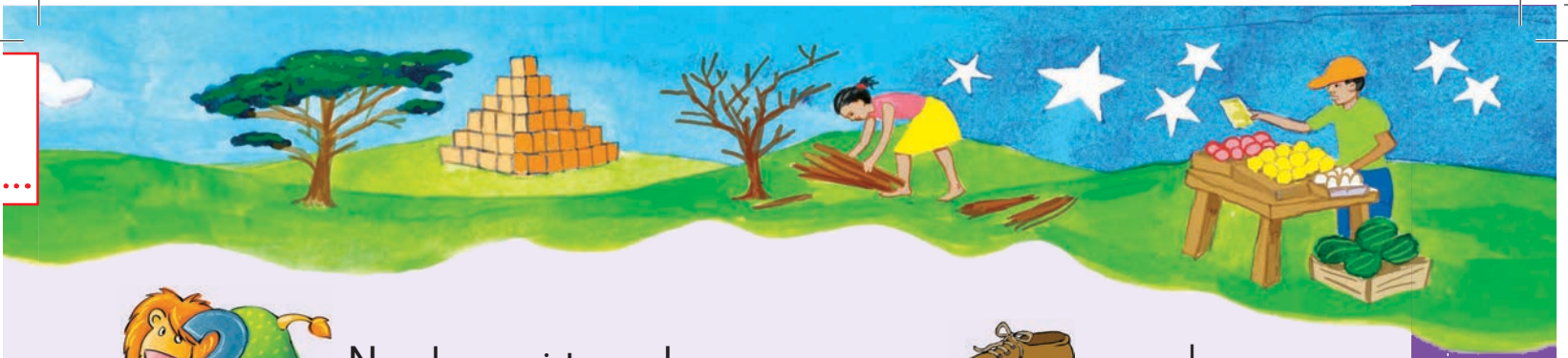

Now draw a pictograph



= one learner

Size 1	Size 2	Size 3	Size 4	Size 5	Size 6



Now answer these questions.

a. Most learners wear shoe size \_\_\_\_\_.

b. The fewest number wear size \_\_\_\_\_.

c. \_\_\_\_\_ children took part in this survey.



What about you?

Find out what shoe sizes you and your friends wear!

- Work in a group of 6 to 8.
- Collect your data.
- Write the number of shoe sizes in a table.
- Compare answers with other groups.



Teacher: \_\_\_\_\_

Sign: \_\_\_\_\_

Date: \_\_\_\_\_



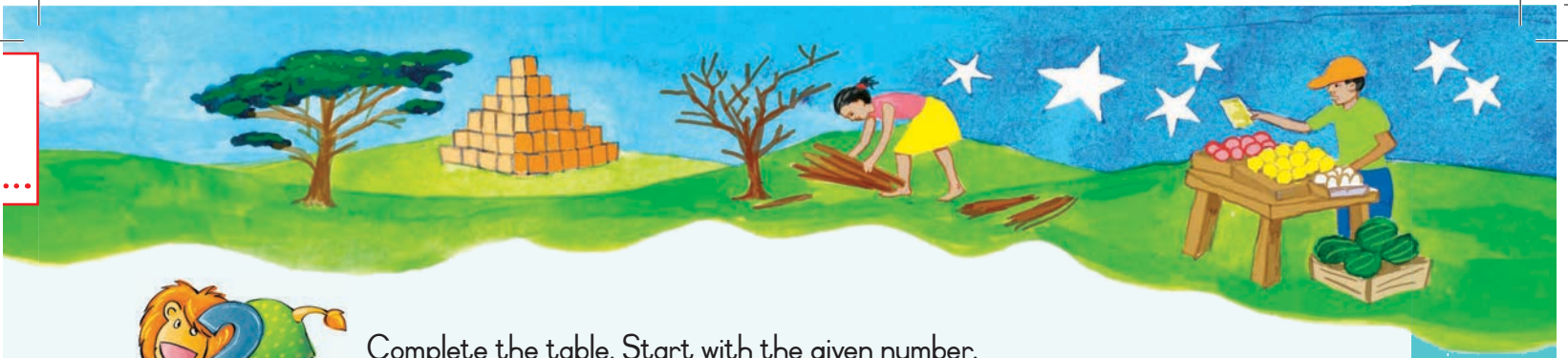

Complete the table. Start with the given number.

	one more	one less	ten more	ten less
25				
39				
74				
56				
40				



Circle the biggest number.

78    87    17            36    63    33

Circle the smallest number.

99    19    9            14    41    40



If  $<$  means *smaller than*, and  $>$  means *bigger than*, complete:

32  $<$  64            23  $>$  18

57  $\square$  98            89  $\square$  57



Find 5 numbers in a newspaper between 50 and 99 and paste them in order from the smallest to the biggest.



Teacher: \_\_\_\_\_

Sign: \_\_\_\_\_

Date: \_\_\_\_\_

Date: \_\_\_\_\_

18

# Place value to 99

Term 1



## Showing numbers using objects

We can show numbers with place value blocks.

A small block stands for a 1. It is a **unit**.

A rod of 10 small blocks stands for a 10. It is a **ten**.

Tens	Units

You can show a number using tens and units.

Here is how to show 47.

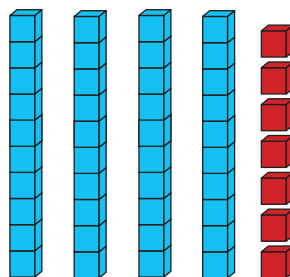

Tens	Units
4	7

forty-seven  
47



## Writing numbers in digits and words

- a. Under the picture, write how many tens and how many units.  
Then write the number in symbols and words.

Tens 3	Units 1	Tens	Units	Tens	Units
31 thirty-one		_____		_____	





b. We can also use our number cards to show it.

Number	How many tens?	How many units?	Write the number in words
26	2	6	twenty-six
46			
99			



What is the number?

		<table border="1"> <thead> <tr> <th>Tens</th> <th>Units</th> </tr> </thead> <tbody> <tr> <td>3</td> <td>5</td> </tr> </tbody> </table> <p>thirty-five 35</p>	Tens	Units	3	5
Tens	Units					
3	5					
		<table border="1"> <thead> <tr> <th>Tens</th> <th>Units</th> </tr> </thead> <tbody> <tr> <td></td> <td></td> </tr> </tbody> </table> <p>_____</p> <p>_____</p>	Tens	Units		
Tens	Units					
		<table border="1"> <thead> <tr> <th>Tens</th> <th>Units</th> </tr> </thead> <tbody> <tr> <td></td> <td></td> </tr> </tbody> </table> <p>_____</p> <p>_____</p>	Tens	Units		
Tens	Units					



Date: \_\_\_\_\_

19

# Putting tens together when we add to 99

Term 1



Reading

Here is one way to show 22.

Tens	Units
1 ten	12 units
1 0	1 0 2

We have one ten

We have twelve units.

We will put 10 of the units in a group.

Now we have another way to show 22.

Tens	Units
2 tens	2 units
2 2	

Let's add  $27 + 4$ . The blue blocks are the units we start with and the red units are the units we are adding to them.

27 is 2 tens and 7 units. Then we add 4 more units.

Tens	Units
2 tens	7 units
	+ 4 units
2 0	7 4

We have 2 tens and 11 units.

We can show 10 units as 1 ten.

Tens	Units
2 0	1 0 1

Now we have 3 tens + 1 unit = 31

Tens	Units
3 1	

+ =



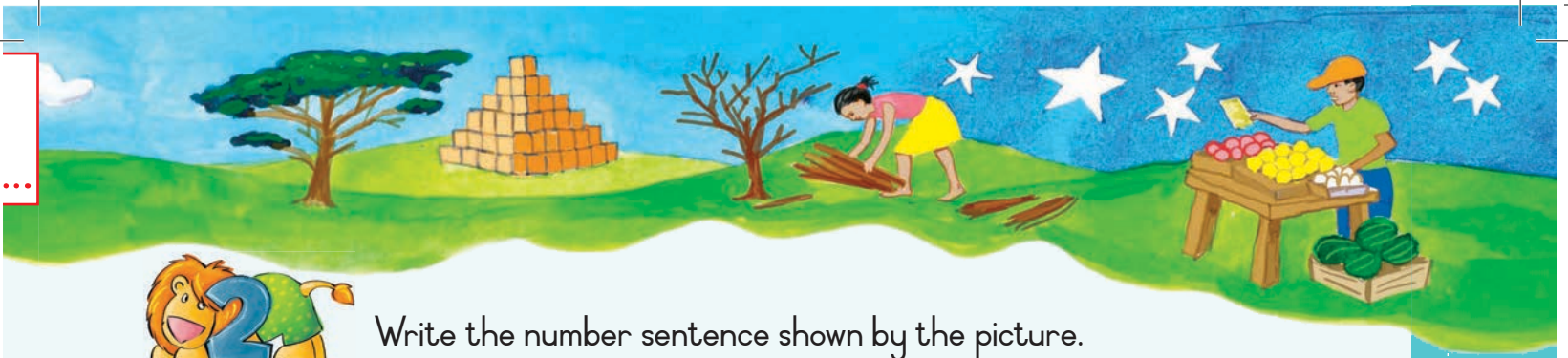

Write the number sentence shown by the picture.

Tens	Units	Tens	Units	Tens	Units
<input style="width: 50px; height: 30px;" type="text"/>	<input style="width: 30px; height: 30px;" type="text"/> <input style="width: 30px; height: 30px;" type="text"/>	<input style="width: 50px; height: 30px;" type="text"/> <input style="width: 50px; height: 30px;" type="text"/> <input style="width: 30px; height: 30px;" type="text"/>	<input style="width: 50px; height: 30px;" type="text"/> <input style="width: 50px; height: 30px;" type="text"/> <input style="width: 30px; height: 30px;" type="text"/>	<input style="width: 50px; height: 30px;" type="text"/>	<input style="width: 30px; height: 30px;" type="text"/>
$10 + 5 + 6$		$\underline{\quad} + \underline{\quad} + \underline{\quad}$		$\underline{\quad} + \underline{\quad} = \underline{\quad}$	

Complete the pictures. Write the number sentences shown by the picture.

Tens	Units	Tens	Units	Tens	Units
<input style="width: 100%; height: 30px;" type="text"/>		<input style="width: 100%; height: 30px;" type="text"/>		<input style="width: 100%; height: 30px;" type="text"/>	
Tens	Units	Tens	Units	Tens	Units
<input style="width: 100%; height: 30px;" type="text"/>		<input style="width: 100%; height: 30px;" type="text"/>		<input style="width: 100%; height: 30px;" type="text"/>	



Teacher: \_\_\_\_\_

Sign: \_\_\_\_\_

Date: \_\_\_\_\_

## Add on a number line

### Sit at your desk!

In our school each learner has their own desk.  
There are 46 learners in Grade 3A and 24 in Grade 3B.  
How many desks do we need for both classes?

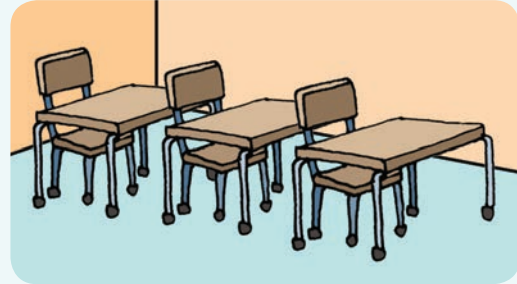

### Working with a partner

Look at how these three learners used a number line to solve the problem. Complete the sums using the example.

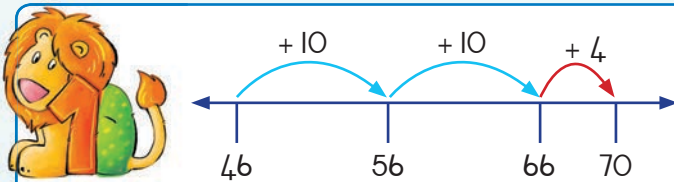

This is what I do: I first add 10. This brings me to 56.  
Then I jump another 10 to get to 66.  
And lastly, I jump 4 more to land at 70.

I must add  
24 to 46.

$$\begin{aligned} &= 46 + 10 + 10 + 4 \\ &= 56 + 10 + 4 \\ &= 66 + 4 \\ &= 70 \end{aligned}$$



a.  $32 + 25 =$

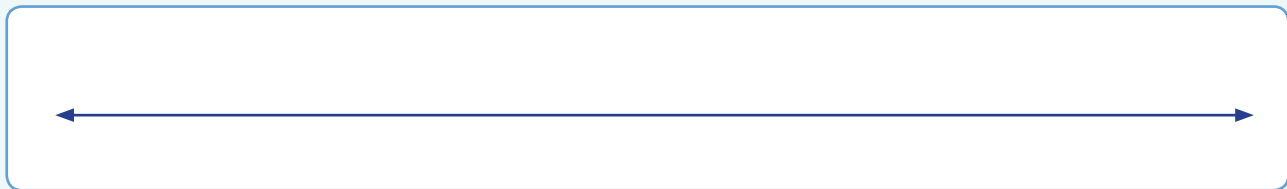

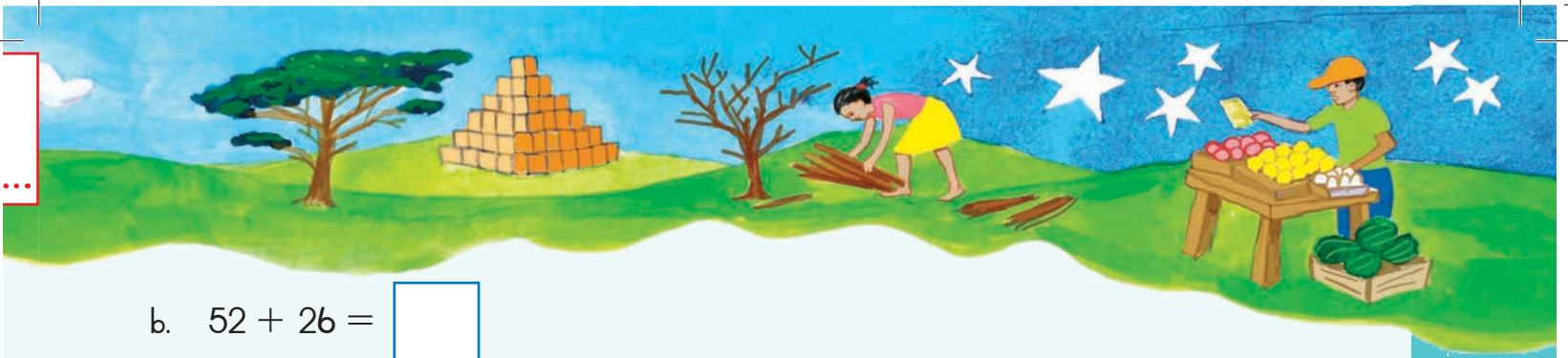

b.  $52 + 26 =$

c.  $46 + 25 =$

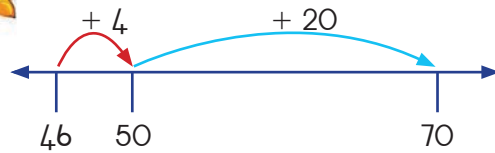

I must add 24 to 46.



This is what I do: First I will jump 4. That will bring me to 50.  
I can jump 20 more, which brings me to 70.

$$= 40 + 10 + 20$$

$$= 50 + 20$$

$$= 70$$

a.  $36 + 41 =$



Teacher: \_\_\_\_\_

Sign: \_\_\_\_\_

Date: \_\_\_\_\_

20b

Date:

Term 1

## Add on a number line (continued)

b.  $57 + 19 = \square$

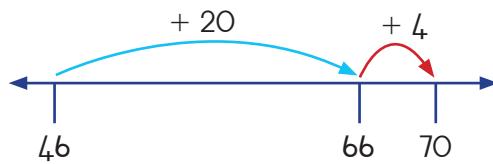

I must add 24 to 46.

This is what I do: From 46, I can jump 20. That brings me to 66.  
Now I have to jump 4 more and then I reach 70.

$$\begin{aligned} &= 46 + 20 + 4 \\ &= 66 + 4 \\ &= 70 \end{aligned}$$



a.  $63 + 24 = \square$

b.  $65 + 29 = \square$

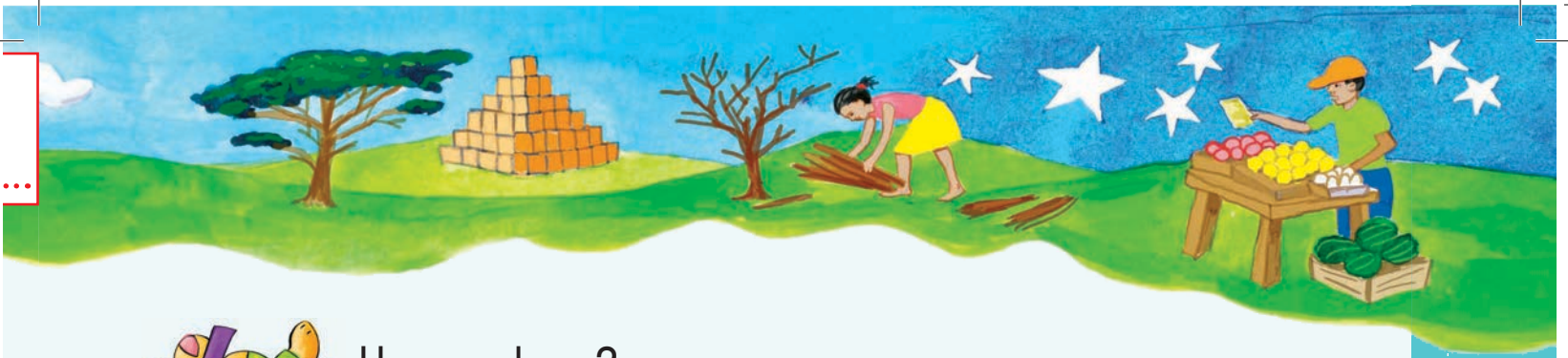

How many loaves?

The baker delivers 54 brown  and 68 white  loaves.

a. How many loaves altogether?

b. Find the total on a number line. Show the **numbers** and the **size** of the jumps.

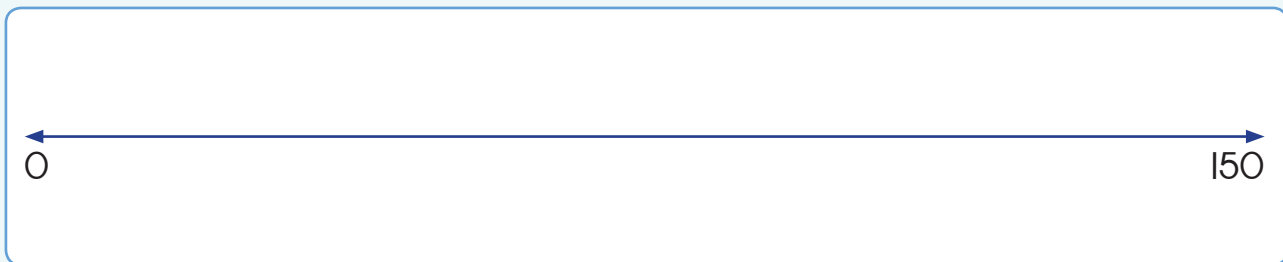

Add the following without using a number line. Use any other method you like.

$$38 + 24 =$$

$$58 + 17 =$$

$$75 + 16 =$$

$$83 + 29 =$$



Teacher:  
Sign:  
Date:

## Subtract on a number line

One learner! One ruler!

The class needs 53 rulers. We have only 35.

How many more do we need?  $53 - 35 =$

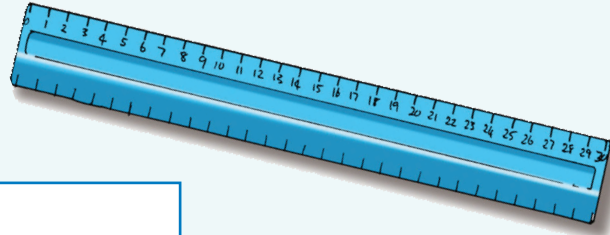

Working with a partner

Read how the same three learners use a number line here. Complete the sums using the example.

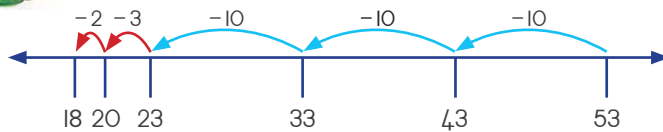

I have to subtract 35 from 53. Subtraction means to **take away**.



So, I will start at 53 and take away. I'll **take away** 10, 10, 10 – that brings me to **23**. Now to take away five. First I take away 3, and I come to **20**. I take away 2 more and I get to **18**. So we need **18** rulers.

$$= 53 - 10 - 10 - 10 - 3 - 2$$

$$= 43 - 10 - 10 - 3 - 2$$

$$= 33 - 10 - 3 - 2$$

$$= 23 - 3 - 2$$

$$= 20 - 2$$

$$= 18$$



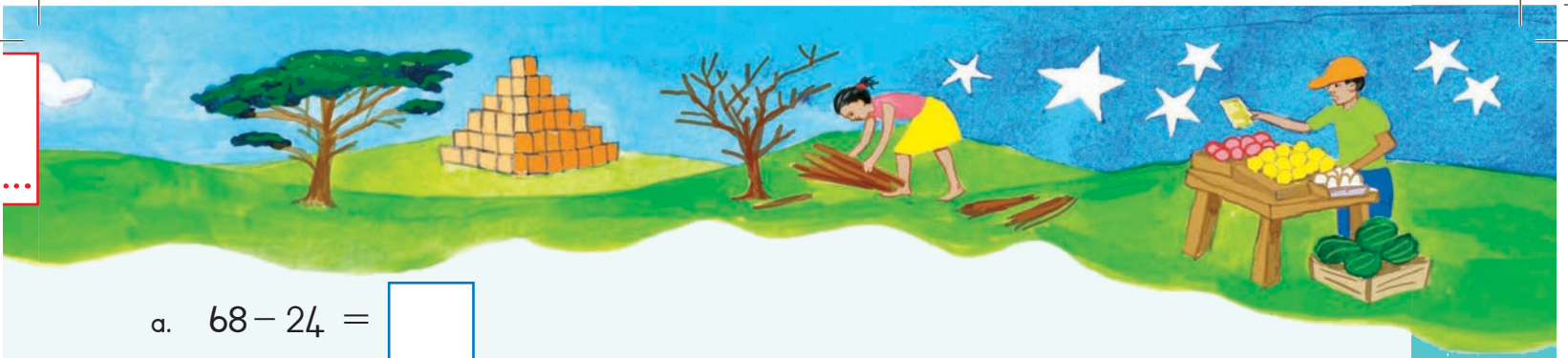

a.  $68 - 24 = \square$

b.  $74 - 38 = \square$

c.  $92 - 87 = \square$

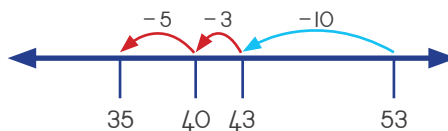

Subtraction means to find the **difference** between 53 and 35.



I'll start at 53 and **count down** to 35 to **find the difference**. If I count back by 10, I get to 43. I can count back 3 more to get to 40. Then I count down 5 more to get to 35.

10 plus 3 plus five is 18. So we need 18 more rulers.

a.  $38 - 14 = \square$



Teacher: \_\_\_\_\_

Sign: \_\_\_\_\_

Date: \_\_\_\_\_

## Subtract on a number line (continued)

b.  $65 - 43 = \square$

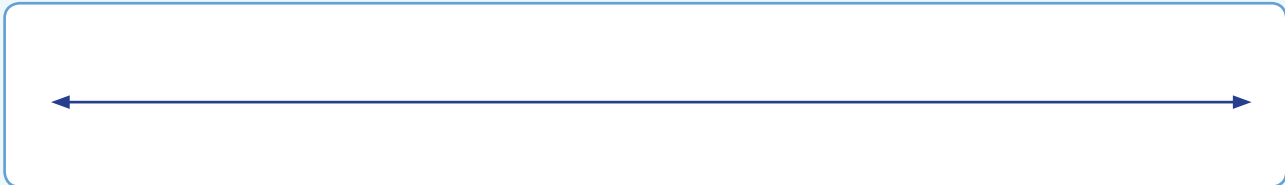

c.  $72 - 39 = \square$

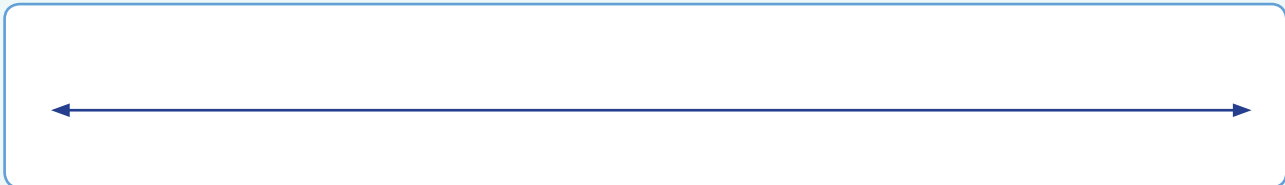

d.  $85 - 48 = \square$

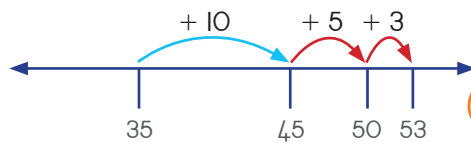
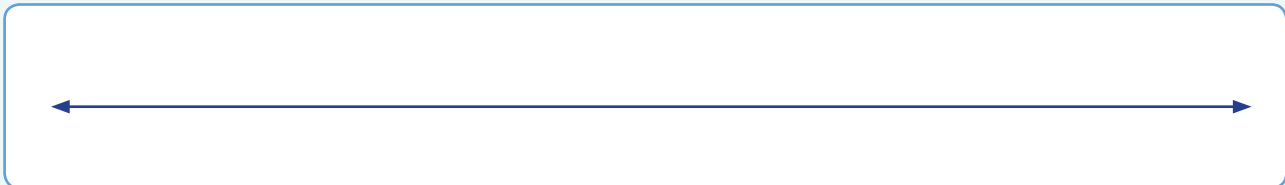

I can start at 35 and see how many jumps it takes me to **count up** to 53.



I can start at 35 and see how many jumps it takes me to **count up** to 53. Ten plus five plus three is 18. We need 18 more rulers.

a.  $84 - 32 = \square$

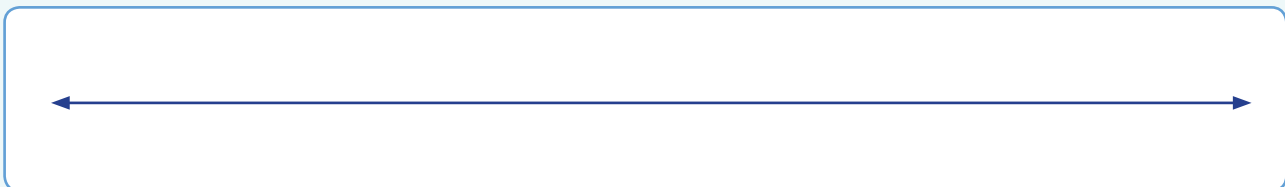



# It's party time



## First plan!

Busi asks all of her friends to give her a picture of their favourite party food. This is what she has collected. Help to sort it.



Count, and write how many friends choose each Kind of food.

				
Number				



Date:

# Counting up to 200



Count the apples.

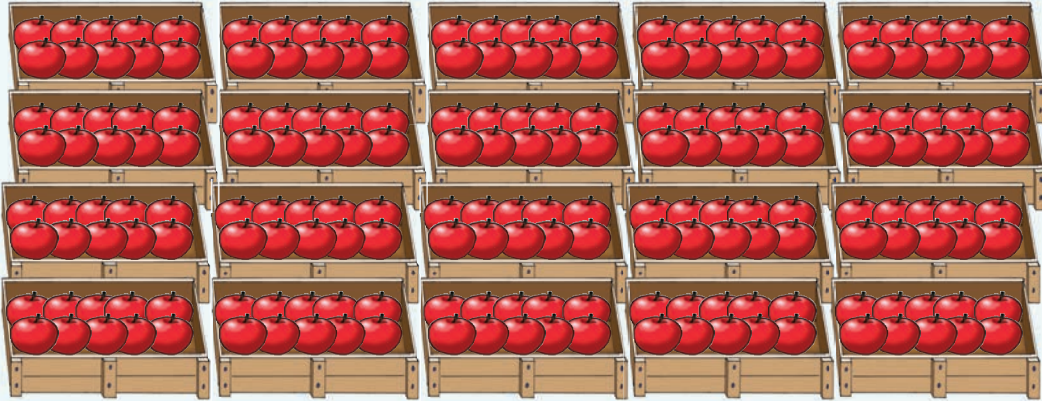

Fill in the numbers.

1 Box has  apples

1 Row has  apples

1 Row has  boxes

4 Rows has  apples



How many apples can we pack in these boxes?

a. 

b. 

c. 



Count on the number line.

a. How many apples will there be in five boxes?

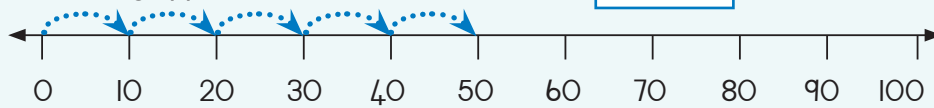

b. How many apples will there be in seven boxes?

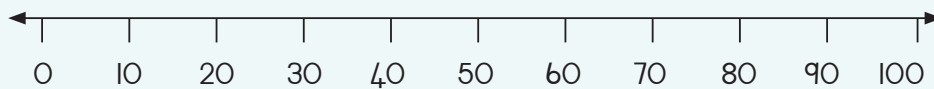



# Practice with 5s

Term 1



How many fish? Make an estimate

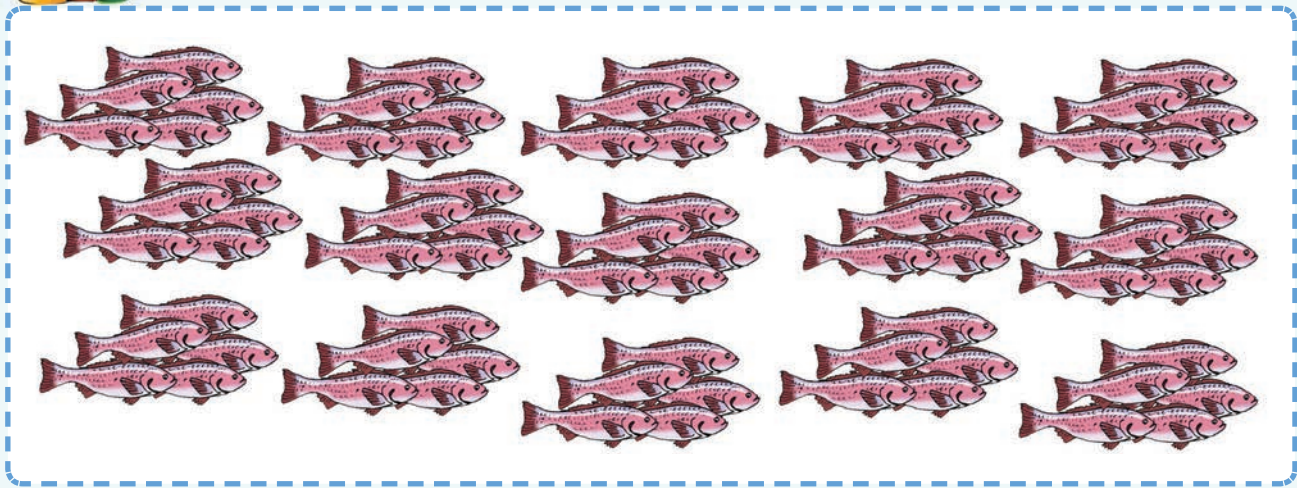

Now count the fish. Find the total.



Counting in 5s

Find the total number of fish eggs. Write a + and × number sentence.

We have done the first one for you.

Fish and eggs	How many eggs altogether?	
5 fish, each lay 2 eggs	$2 + 2 + 2 + 2 + 2 = 10$	$5 \times 2 = 10$
5 fish, each lay 10 eggs		
5 fish, each lay 4 eggs		
5 fish, each lay 3 eggs		
5 fish, each lay 6 eggs		
5 fish, each lay 8 eggs		
5 fish, each lay 5 eggs		



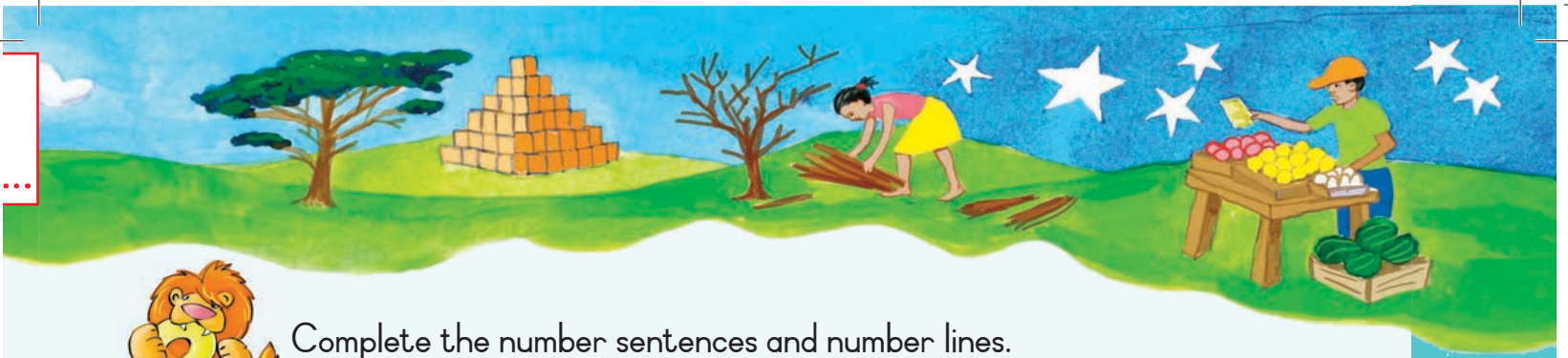

Complete the number sentences and number lines.

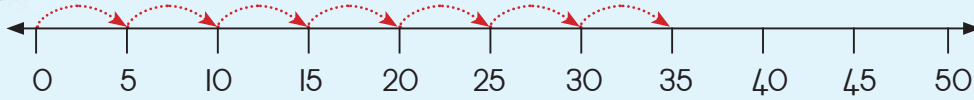

$$5 + 5 + 5 + 5 + 5 + 5 + 5 = \boxed{35} \quad \text{or} \quad \boxed{7} \times \boxed{5} = \boxed{35}$$

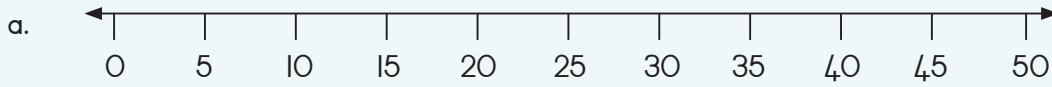

$$5 + 5 + 5 + 5 = \boxed{\phantom{00}} \quad \text{or} \quad \boxed{\phantom{00}} \times \boxed{\phantom{00}} = \boxed{\phantom{00}}$$

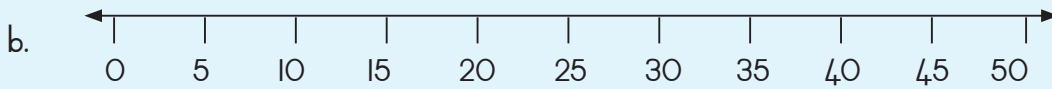

$$5 + 5 + 5 + 5 + 5 + 5 + 5 + 5 + 5 = \boxed{\phantom{00}} \quad \text{or} \quad \boxed{\phantom{00}} \times \boxed{\phantom{00}} = \boxed{\phantom{00}}$$

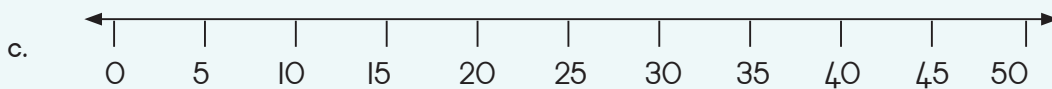

$$\underline{\phantom{00}} + \underline{\phantom{00}} + \underline{\phantom{00}} + \underline{\phantom{00}} + \underline{\phantom{00}} + \underline{\phantom{00}} + \underline{\phantom{00}} + \underline{\phantom{00}} + \underline{\phantom{00}} + \underline{\phantom{00}} = \boxed{\phantom{00}} \quad \text{or} \quad 10 \times 5 = 50$$



### Catching fish

Sipho catches between 40 and 50 fish. He counts them in 2s and has 1 left over.

He counts them in 5s and has 2 left over. How many fish does Sipho catch?

Teacher:

Sign:

Date:



Counting the socks

Count in 2s



a. How many pairs of socks? \_\_\_\_\_

b. How many socks are there? \_\_\_\_\_

c. Are there any socks left over? \_\_\_\_\_



## Counting pairs of socks

Write how many pairs of socks there are and say if there are any left over.

Socks	Number of pairs	Number of socks	Single socks left over



Teacher: \_\_\_\_\_

Sign: \_\_\_\_\_

Date: \_\_\_\_\_

25b

Date:

Term 1

## Count in 2s (continued)



### Building pairs

Write down the even and odd numbers from 1 – 60.

a. Write down the even numbers from 1 – 60.

2, 4, 6,

---

---

b. Write down the odd numbers from 1 – 60.

3, 5, 7,

---

---



### Odds and evens

Draw a circle around the even numbers.

Draw a square around the odd numbers.

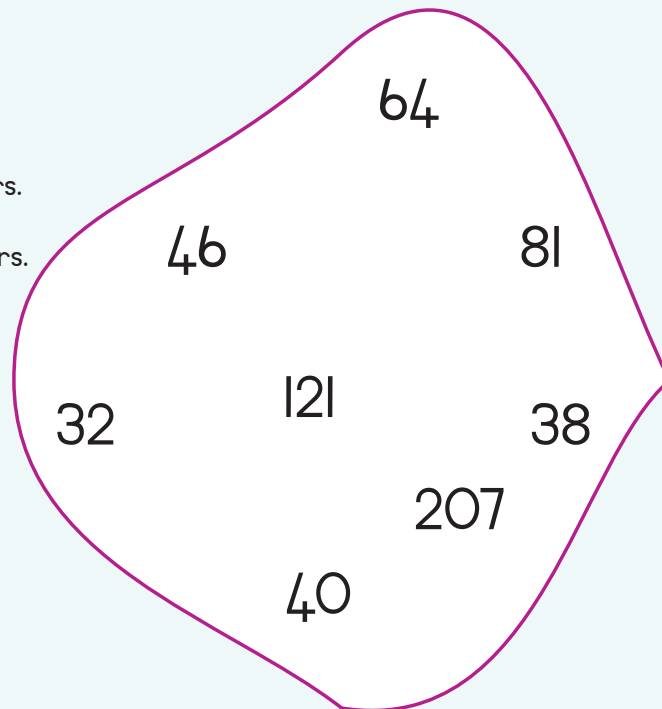

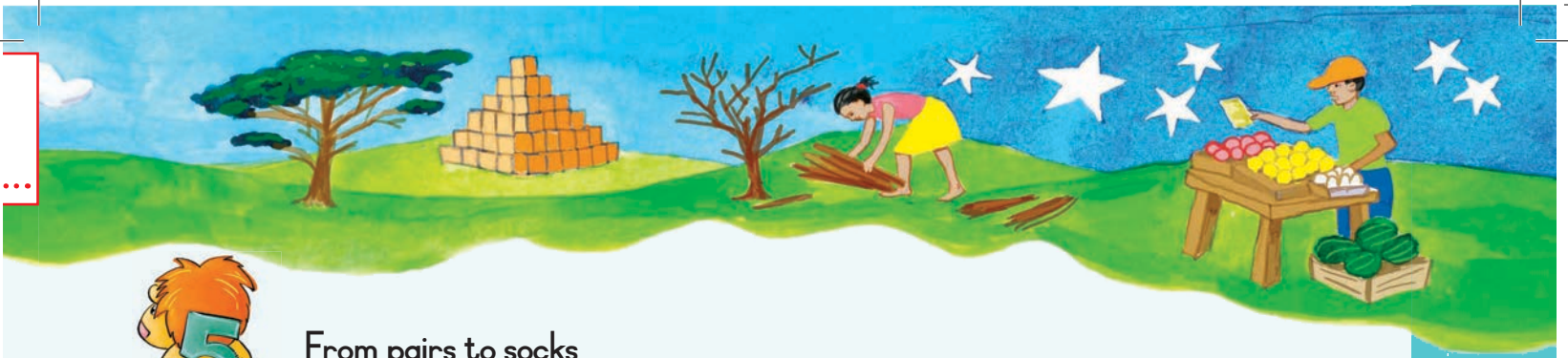

## From pairs to socks

Example:

2 socks = 1 pair 

$$2 \times 1 = 2$$

20 socks = 10 pairs

$$2 \times 10 = 20$$

a. Write how many socks.

Think in 2s	Number sentence
1 pair = 2 socks	$1 \times 2 = 2$
2 pairs = _____ socks	$2 \times 2 = \square$
4 pairs = _____ socks	
8 pairs = _____ socks	
9 pairs = _____ socks	

b. Show the sum on the number line and complete.

Example:

$$2 + 2 + 2 = 6 \text{ or } 3 \times 2 = 6$$

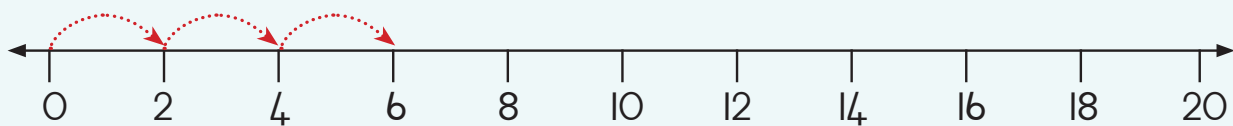

$$2 + 2 + 2 + 2 + 2 + 2 + 2 = \square \text{ or } \square \times \square = \square$$

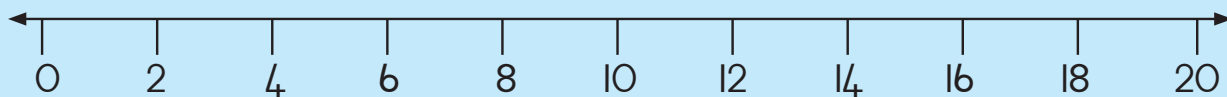

Teacher:

Sign:

Date:

11 12 13 14 15 16 17 18 19 20

# Money then and now



## The story of our money

In South Africa we use rands and cents as our money. We started to use rands and cents in 1961.

In those days the 1 cent coin had the lowest value, then the 2 cent coin and then the 5 cent coin.



<p>I used these small coins to pay for a lot of things. Things were so cheap then!</p>	<p>Yes, you're right, they are no longer being made!</p> <p>But, Gogo, I have not seen 1 and 2 cent coins.</p>
<p>About 50 years ago we still used pounds, shillings and pence.</p>	<p>Yes, I remember! 1 pound was 20 shillings, and 1 shilling was 12 pence.</p>

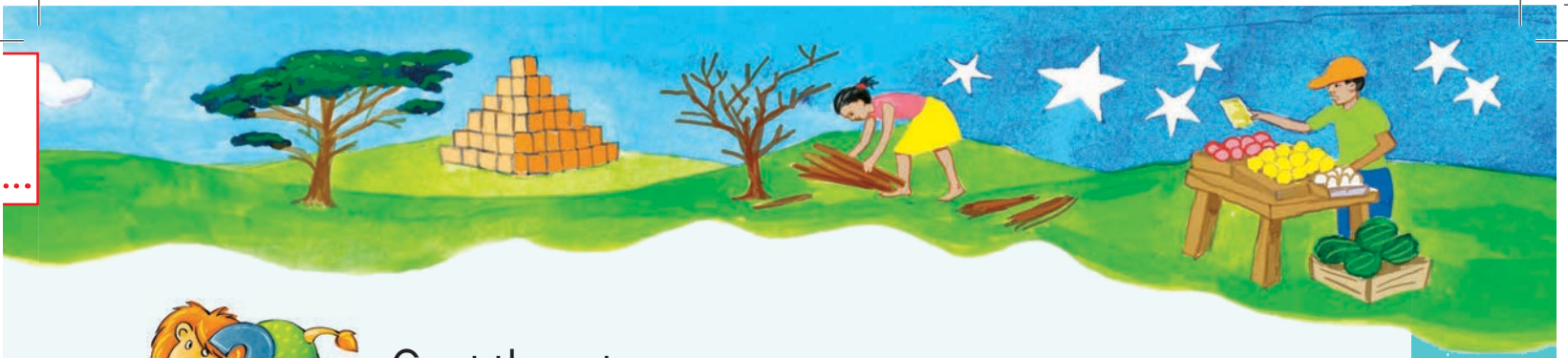

### Count the cents

Count the 1 cents.

How many cents are there?

How many more cents do you need to make R1,00?

Draw them in the block.

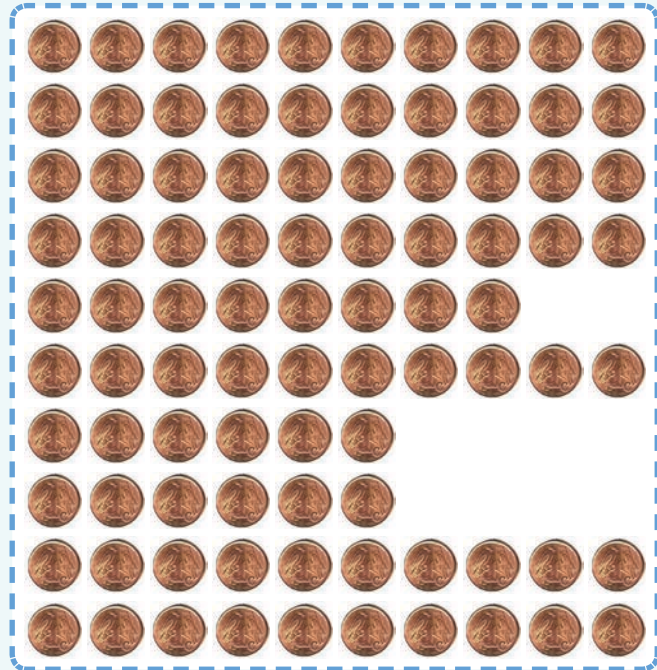

### How many cents?

R1,00 = <input type="text"/> c	R2,00 = <input type="text"/> c
R3,00 = <input type="text"/> c	R1,50 = <input type="text"/> c



### How much fruit can I buy?



2 cost R4,00.

How many bananas for R20,00?



2 cost R2,00.

How many apples for R9,00?



Teacher: \_\_\_\_\_

Sign: \_\_\_\_\_

Date: \_\_\_\_\_

## Count in 3s

Term 1



Wheels in 3s



1 tricycle has \_\_\_\_\_ wheels.



5 tricycles have \_\_\_\_\_ wheels.

$$3 + 3 + 3 + 3 + 3 = 5 \times 3 = \underline{\quad}$$

2 tricycles have \_\_\_\_\_ wheels.

$$3 + 3 = 2 \times 3 = \underline{\quad}$$

4 tricycles have \_\_\_\_\_ wheels.

6 tricycles have \_\_\_\_\_ wheels.

9 tricycles have \_\_\_\_\_ wheels.

8 tricycles have \_\_\_\_\_ wheels.



Number lines

Follow the example.

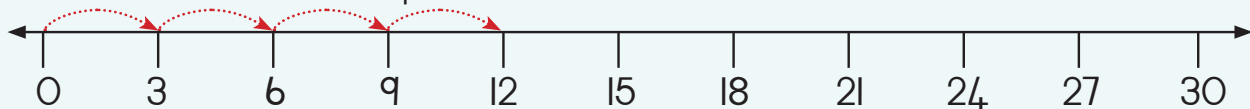

a.  $3 + 3 + 3 + 3 = \square = 4 \times 3 = \square$



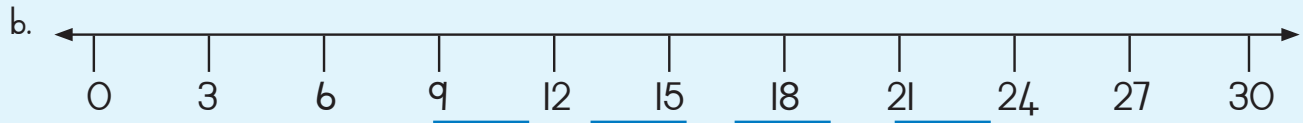
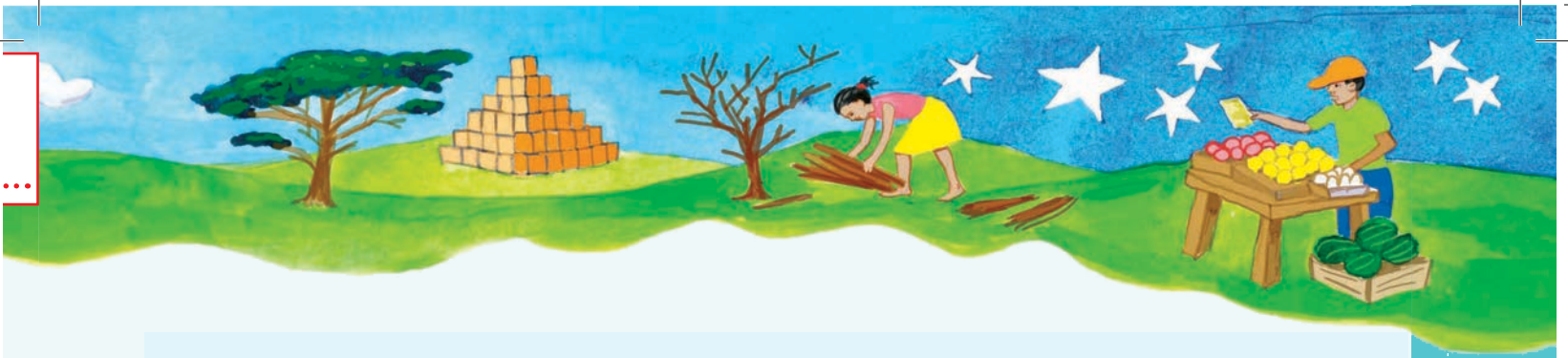

$$3 + 3 + 3 + 3 + 3 = \boxed{\phantom{00}} = \boxed{\phantom{00}} \times \boxed{\phantom{00}} = \boxed{\phantom{00}}$$

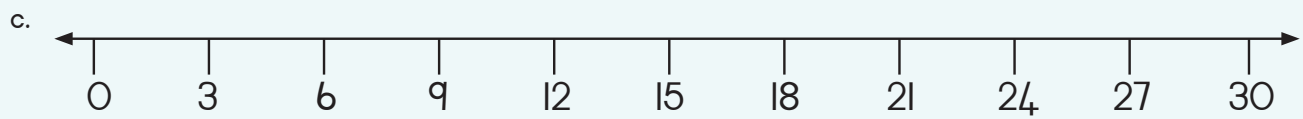

$$\underline{\hspace{10em}} = \boxed{\phantom{00}} = 6 \times 3 = \boxed{\phantom{00}}$$

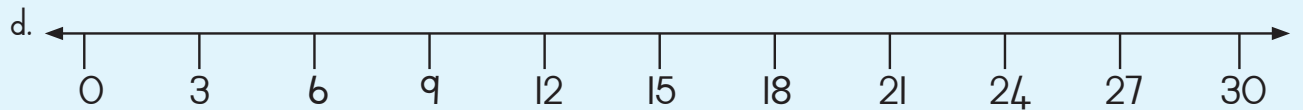

$$\underline{\hspace{10em}} = \boxed{\phantom{00}} = 10 \times 3 = \boxed{\phantom{00}}$$



### Bicycles and tricycles



At the cycle shop Busi counts bicycle and tricycle wheels.

There are 14 wheels altogether.

How many bicycles are there? \_\_\_\_\_

How many tricycles are there? \_\_\_\_\_



Teacher: \_\_\_\_\_  
 Sign: \_\_\_\_\_  
 Date: \_\_\_\_\_

## What comes in 4s?



Four legs

Some 4 number facts ...  
 $4 + 4 = 8$ ;  $2 \times 4 = 8$ 

Cows have four legs.











What else comes in fours? \_\_\_\_\_



Counting the legs

Share answers.  
Explain what you did.

Use the facts you know about 4s to answer these questions.

1 cow  <input type="text" value="4"/> legs	2 cows  <input type="text" value="8"/> legs
3 cows  <input type="text"/>	4 cows  <input type="text"/> legs
5 cows  <input type="text"/> legs	6 cows  <input type="text"/> legs
7 cows  <input type="text"/> legs	8 cows  <input type="text"/> legs
9 cows  <input type="text"/> legs	10 cows  <input type="text"/> legs

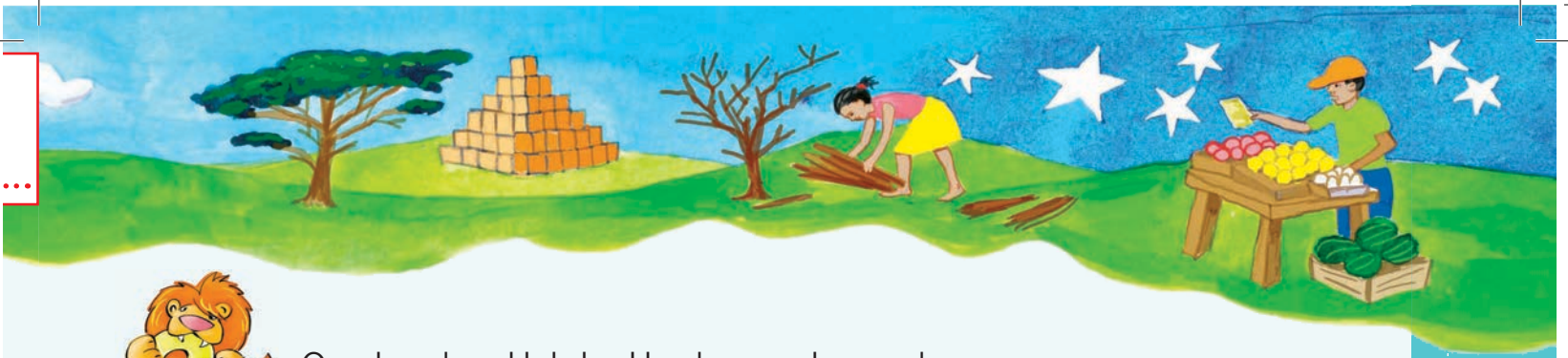

Complete the table below. Use the example to guide you.

3 cows have _____ legs.	$4 + 4 + 4 = 3 \times 4 = \underline{12}$
5 cows have _____ legs.	
4 cows have _____ legs.	
7 cows have _____ legs.	
8 cows have _____ legs.	



### Number lines

Show the multiplication sum on the number line and complete using jumps (hops).

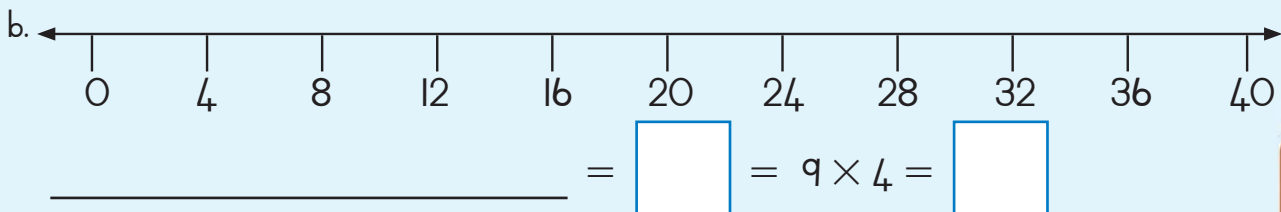
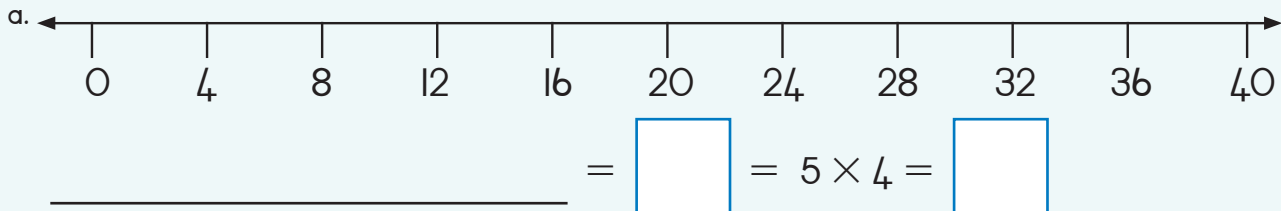

# Patterns in numbers

Term 1



## Grid patterns

Which number pattern do the circles in each 100 grid show?

Draw more circles to complete each pattern.

Write a name for each pattern.

a. Pattern: \_\_\_\_\_

				○					○
				○					○
				○					○
				○					○
				○					○
				○					○
				○					○

b. Pattern: \_\_\_\_\_

	○		○		○		○		○
	○		○		○		○		○
	○		○		○		○		○
	○		○		○		○		○
	○		○		○		○		○
	○		○		○		○		○
	○		○		○		○		○

c. Pattern: \_\_\_\_\_

		○			○				○
		○			○				○
○			○			○			○
		○			○				○
	○			○			○		
○			○						

d. Pattern: \_\_\_\_\_

			○				○		
	○			○				○	
		○			○				○
	○			○				○	

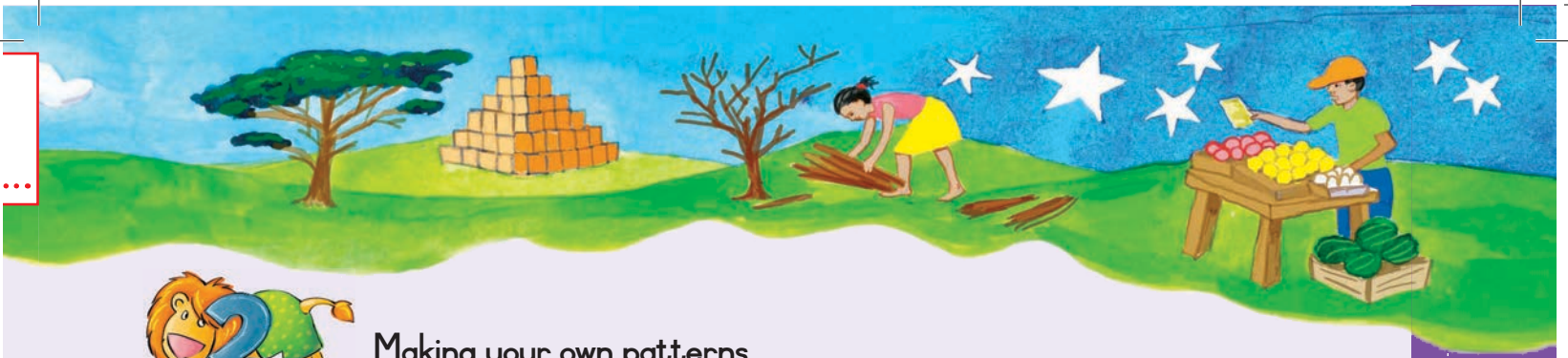

## Making your own patterns

- a. In this number pattern all the numbers are even. What can the other numbers be?  
Write them in.



- b. In this number pattern the numbers are all odd. What can the other numbers be? Write them in.

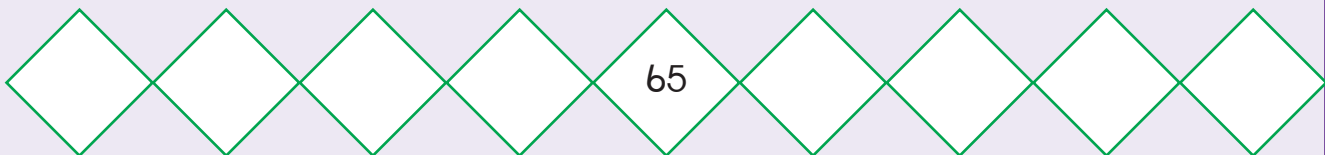

## Where do they belong?



The 3s and 4s pattern	The 3s and 5s pattern	The 4s and 5s pattern
e. g. 48		



## At the sea

Thembi collects **between 60 and 70** sea shells.  
When she counts them in 3s, she has 1 left over.  
The possible numbers are: 61, \_\_\_\_\_, \_\_\_\_\_, 70.  
When she counts them in 5s, she has 4 left over.  
The possible numbers are: \_\_\_\_\_, \_\_\_\_\_.  
How many shells does Thembi have? \_\_\_\_\_.



Teacher: \_\_\_\_\_

Sign: \_\_\_\_\_

Date: \_\_\_\_\_

11 12 13 14 15 16 17 18 19 20

## Division



Share the sweets:

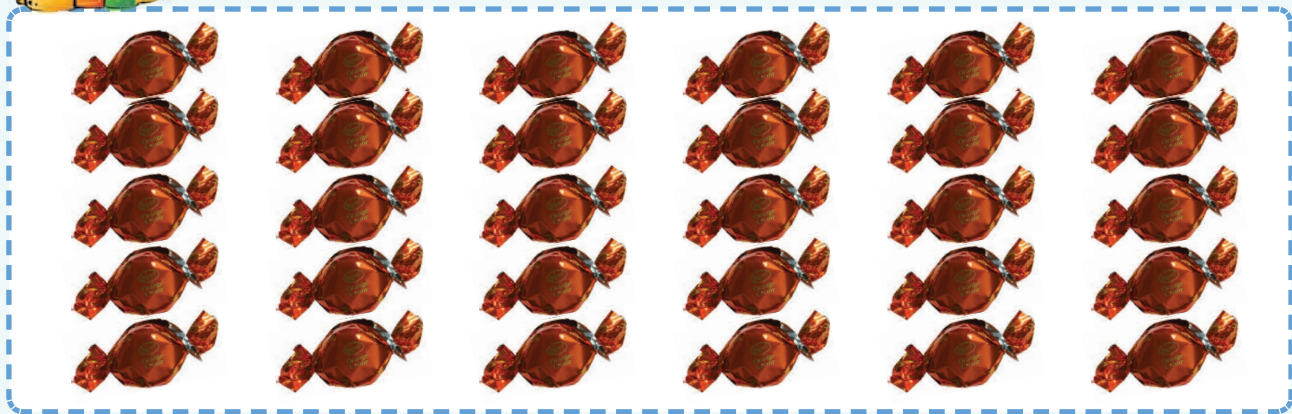

a. Share 30 sweets between 2 children.



We can write it as

$$30 \div 2 = 15$$

b. Share the sweets among 3 children.



$$\div =$$

c. Divide the sweets between 5 children.

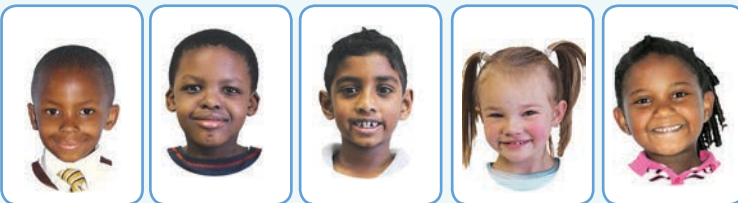

$$\div =$$



We can use number blocks to do division.

$\begin{array}{ c c } \hline 2 & 8 \\ \hline \end{array} \div \begin{array}{ c } \hline 2 \\ \hline \end{array} = \begin{array}{ c c } \hline 4 & 2 \\ \hline \end{array}$	

Now do these.

a.

$\begin{array}{ c c } \hline \phantom{0} & \phantom{0} \\ \hline \end{array} \div \begin{array}{ c } \hline 3 \\ \hline \end{array} = \begin{array}{ c c } \hline \phantom{0} & \phantom{0} \\ \hline \end{array}$	

b.

$\begin{array}{ c c } \hline \phantom{0} & \phantom{0} \\ \hline \end{array} \div \begin{array}{ c } \hline 4 \\ \hline \end{array} = \begin{array}{ c c } \hline \phantom{0} & \phantom{0} \\ \hline \end{array}$	



Teacher: \_\_\_\_\_

Sign: \_\_\_\_\_

Date: \_\_\_\_\_

30b

Date:

# Division (continued)

Term 1



Use the number lines to write a subtraction and division number sentence.

Example:

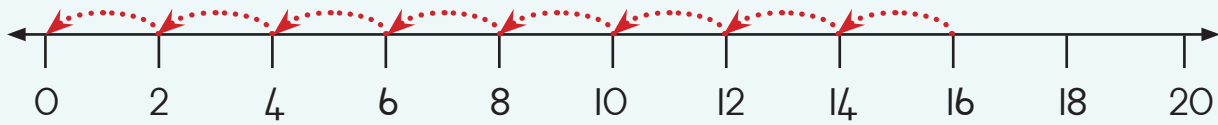

$$16 - 2 - 2 - 2 - 2 - 2 - 2 - 2 - 2 = 0$$

$$16 \div 2 = 8$$

a.

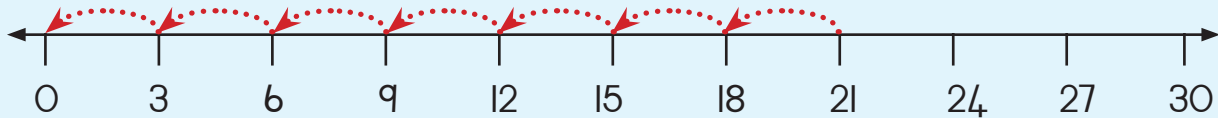

$$21 - \underline{\hspace{2cm}} = \underline{\hspace{2cm}}$$
  
$$\boxed{\hspace{1cm}} \div \boxed{\hspace{1cm}} = \underline{\hspace{2cm}}$$

b.

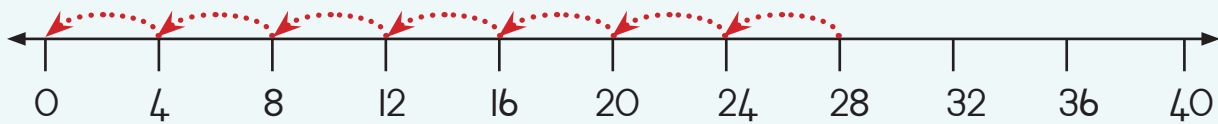

$$28 - \underline{\hspace{2cm}} = \underline{\hspace{2cm}}$$
  
$$\boxed{\hspace{1cm}} \div \boxed{\hspace{1cm}} = \underline{\hspace{2cm}}$$

c.

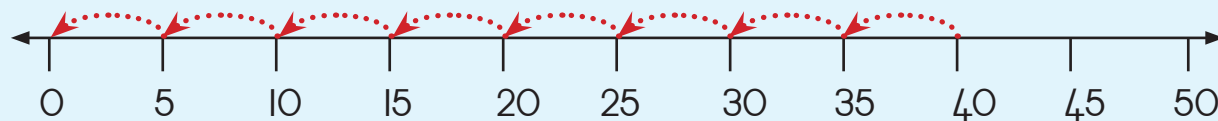

$$\underline{\hspace{1cm}} - \underline{\hspace{2cm}} = \underline{\hspace{2cm}}$$
  
$$\boxed{\hspace{1cm}} \div \boxed{\hspace{1cm}} = \underline{\hspace{2cm}}$$



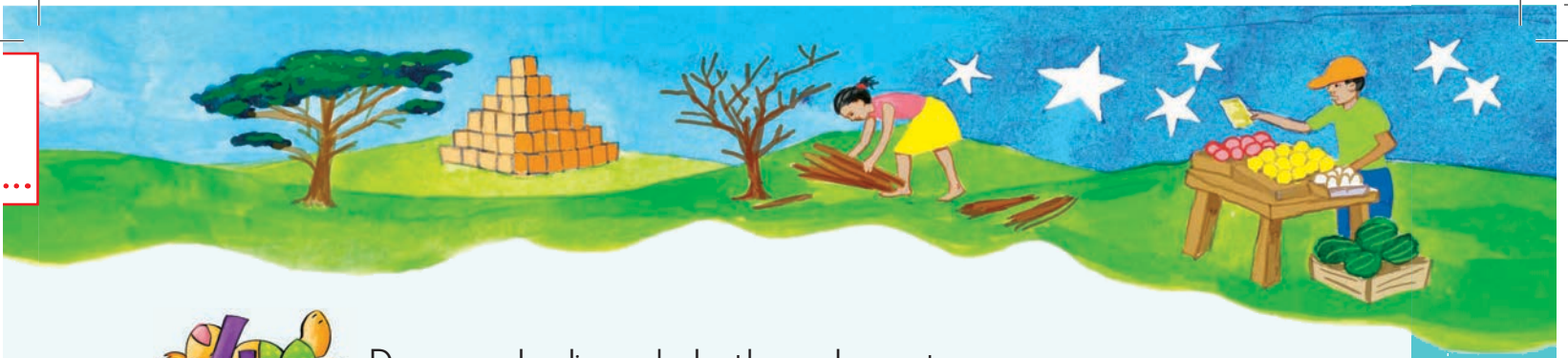

Draw a number line and solve the number sentences.

a.  $30 \div 5 =$



b.  $22 \div 2 =$



c.  $27 \div 3 =$



d.  $32 \div 4 =$



e.  $25 \div 5 =$



### Challenge

Show all the ways you can divide 24 sweets equally between different groups of children.

Write a number sentence to show your answer.

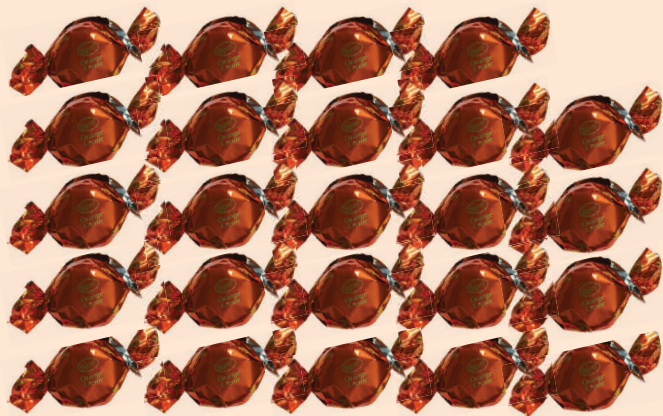

Teacher: \_\_\_\_\_

Sign: \_\_\_\_\_

Date: \_\_\_\_\_

## Fractions

Term 1

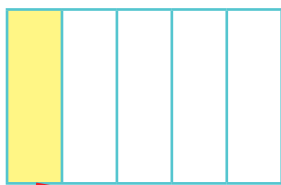
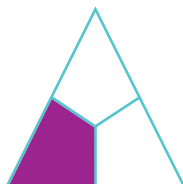
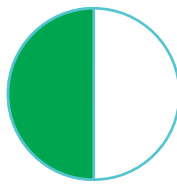
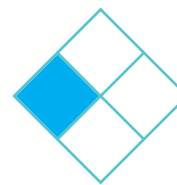

Draw lines to match the shape with the fraction

One third  $\frac{1}{3}$ One fifth  $\frac{1}{5}$ One quarter  $\frac{1}{4}$ One half  $\frac{1}{2}$ Three quarters  $\frac{3}{4}$ Four fifths  $\frac{4}{5}$ 

One whole 1

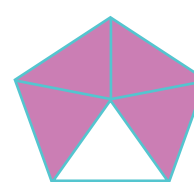
Two thirds  $\frac{2}{3}$ 

Divide and then colour the shape to show the fraction:

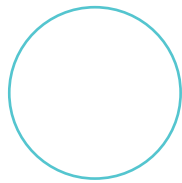
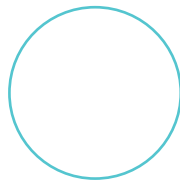
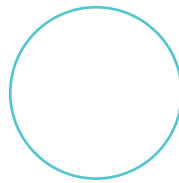
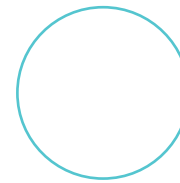
One half  $\frac{1}{2}$ One third  $\frac{1}{3}$ One quarter  $\frac{1}{4}$ One fifth  $\frac{1}{5}$ 

Show the fraction by drawing a line around the correct number of sweets:

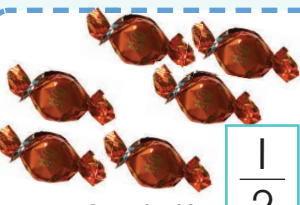
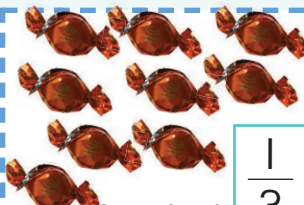
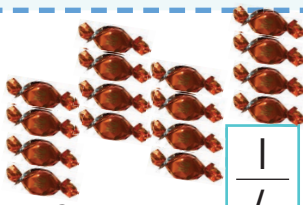
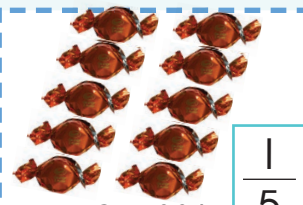
One half  $\frac{1}{2}$ One third  $\frac{1}{3}$ One quarter  $\frac{1}{4}$ One fifth  $\frac{1}{5}$



Share the counters between the two children.

<table border="1" style="width: 100%;"> <tr> <td style="text-align: center;">😊</td> <td style="text-align: center;">😊</td> </tr> <tr> <td style="text-align: center;">●●</td> <td style="text-align: center;">●●</td> </tr> </table>	😊	😊	●●	●●	<table border="1" style="width: 100%;"> <tr> <td style="text-align: center;">😊</td> <td style="text-align: center;">😊</td> </tr> <tr> <td style="text-align: center;">●●●</td> <td style="text-align: center;">●●●</td> </tr> </table>	😊	😊	●●●	●●●	<table border="1" style="width: 100%;"> <tr> <td style="text-align: center;">😊</td> <td style="text-align: center;">😊</td> </tr> <tr> <td style="text-align: center;">●●●●</td> <td style="text-align: center;">●●●●</td> </tr> </table>	😊	😊	●●●●	●●●●	<table border="1" style="width: 100%;"> <tr> <td style="text-align: center;">😊</td> <td style="text-align: center;">😊</td> </tr> <tr> <td style="text-align: center;">●●●●●</td> <td style="text-align: center;">●●●●●</td> </tr> </table>	😊	😊	●●●●●	●●●●●
😊	😊																		
●●	●●																		
😊	😊																		
●●●	●●●																		
😊	😊																		
●●●●	●●●●																		
😊	😊																		
●●●●●	●●●●●																		
<ul style="list-style-type: none"> <li>We got <u>2</u> counters each.</li> <li>Half of <u>4</u> counters is <u>2</u>.</li> </ul>	<ul style="list-style-type: none"> <li>We got _____ counters each.</li> <li>_____ of _____ counters is _____.</li> </ul>	<ul style="list-style-type: none"> <li>We got _____ counters each.</li> <li>_____ of _____ counters is _____.</li> </ul>	<ul style="list-style-type: none"> <li>We got _____ counters each.</li> <li>_____ of _____ counters is _____.</li> </ul>																
$4 \div 2 = 2$	_____ $\div$ _____ = _____	_____ $\div$ _____ = _____	_____ $\div$ _____ = _____																



Share the sweets between the children.

<table border="1" style="width: 100%;"> <tr> <td style="text-align: center;">😊</td> <td style="text-align: center;">😊</td> <td style="text-align: center;">😊</td> <td style="text-align: center;">😊</td> </tr> <tr> <td style="height: 50px;"></td> <td style="height: 50px;"></td> <td style="height: 50px;"></td> <td style="height: 50px;"></td> </tr> </table>	😊	😊	😊	😊					<table border="1" style="width: 100%;"> <tr> <td style="text-align: center;">😊</td> <td style="text-align: center;">😊</td> <td style="text-align: center;">😊</td> </tr> <tr> <td style="height: 50px;"></td> <td style="height: 50px;"></td> <td style="height: 50px;"></td> </tr> </table>	😊	😊	😊			
😊	😊	😊	😊												
😊	😊	😊													
<ul style="list-style-type: none"> <li>one quarter of the sweets = 3</li> <li>two quarters of the sweets = _____</li> <li>three quarters of the sweets = _____</li> <li>four quarters of the sweets = _____</li> </ul>	<ul style="list-style-type: none"> <li>one third of the sweets = _____</li> <li>two thirds of the sweets = _____</li> <li>three thirds of the sweets = _____</li> </ul>														



Teacher: \_\_\_\_\_

Sign: \_\_\_\_\_



Date: \_\_\_\_\_



Clockwise

# It's about time

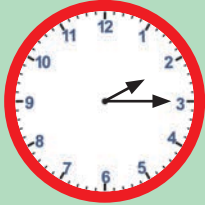
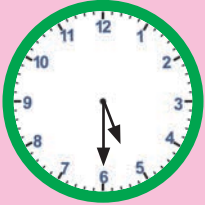
We can write the same time in different ways.

		
<p>2:15 quarter past two</p>	<p>5:30 half past five</p>	<p>9:45 quarter to ten</p>

Write these times in 2 different ways.

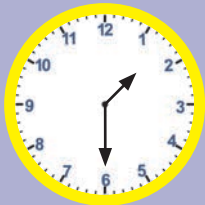
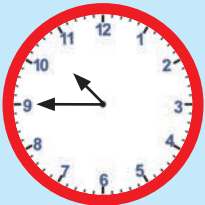
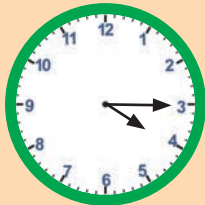

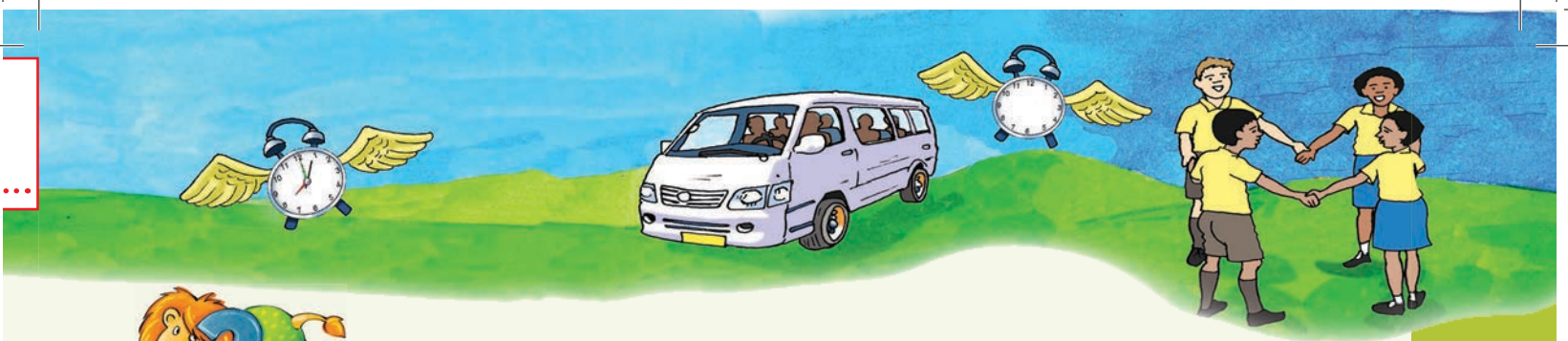
### Going home

How long does Ben take to get home?

minutes

hours



Ben leaves school.

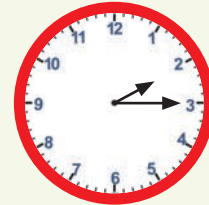

Ben gets home.



### Time flies

Time in 2s ...



How many ...

minutes in 2 hours? \_\_\_\_\_

hours in 2 days? \_\_\_\_\_

days in 2 weeks? \_\_\_\_\_

months in 2 years? \_\_\_\_\_



### How many days?

April 27 is Freedom Day.

June 16 is Youth Day.

April						
M	T	W	T	F	S	S
1	2	3	4	5	6	7
8	9	10	11	12	13	14
15	16	17	18	19	20	21
22	23	24	25	26	27	28
29	30					

May						
M	T	W	T	F	S	S
	1	2	3	4	5	
6	7	8	9	10	11	12
13	14	15	16	17	18	19
20	21	22	23	24	25	26
27	28	29	30	31		

June						
M	T	W	T	F	S	S
					1	2
3	4	5	6	7	8	9
10	11	12	13	14	15	16
17	18	19	20	21	22	23
24	25	26	27	28	29	30

a. From Freedom Day to Youth Day there is \_\_\_\_\_ months,  
\_\_\_\_\_ whole weeks and \_\_\_\_\_ days.

b. How many whole weeks in all? \_\_\_\_\_  
How many days left over? \_\_\_\_\_. How many days in all? \_\_\_\_\_.

c. Lebo's birthday is 7 days before Freedom Day.  
Musa's birthday is two days after Youth Day.

Who is older? \_\_\_\_\_ By how many days? \_\_\_\_\_

Check. Compare.  
Correct.

Teacher: \_\_\_\_\_  
Sign: \_\_\_\_\_  
Date: \_\_\_\_\_

33

Date: \_\_\_\_\_

# Target 200

Term 2



## Counting the numbers

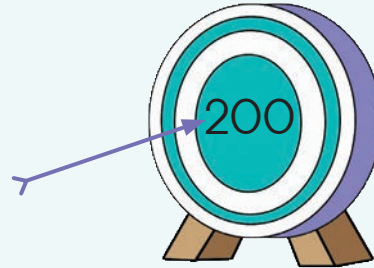

Count and say all the numbers from 101 to 200.  
Point as you go.



101	102								
111									
121									
131									
								149	
			154						
				165					
		173							180
181					186				
							198		200



## Writing the numbers

- Write the missing number in each blue square.
- Write in the rest of the numbers.
- Write the next 10 numbers after 200.

200; \_\_\_\_\_; \_\_\_\_\_; \_\_\_\_\_; \_\_\_\_\_; \_\_\_\_\_; \_\_\_\_\_; \_\_\_\_\_; \_\_\_\_\_; \_\_\_\_\_; \_\_\_\_\_



Write the missing numbers

a.

200		180			
					110
50					
				0	

b.

87		107	
167			
		207	
			237



Complete

200	+	30	+	5	=	235
200	+	40	+	7	=	_____
200	+	60	+	8	=	_____
	+		+		=	293
	+		+		=	256

Write the numbers in order from smallest to biggest.

\_\_\_\_\_

\_\_\_\_\_

\_\_\_\_\_

\_\_\_\_\_

\_\_\_\_\_



Counting on from 100

Work out what you need to get to the next number.

Start

100	→ +25 →	125	→		→	129	→		→	138				
End	←	168	←		←	157	←		←	151	←		←	145



Teacher: \_\_\_\_\_

Sign: \_\_\_\_\_

Date: \_\_\_\_\_

## Working with groups of numbers



### Packing candles

Ma Nkosi works at a candle factory.

When the candles are ready, she packs them out like this in boxes on racks.



How many candles in each box? \_\_\_\_\_

How many boxes on each rack? \_\_\_\_\_

How many candles on each rack? \_\_\_\_\_



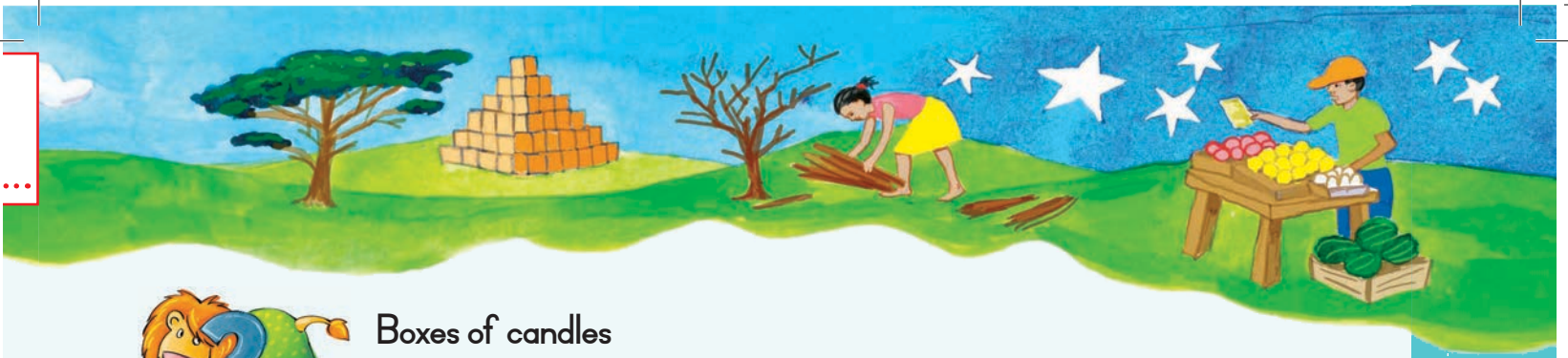

## Boxes of candles

Ma Nkosi closes the boxes.

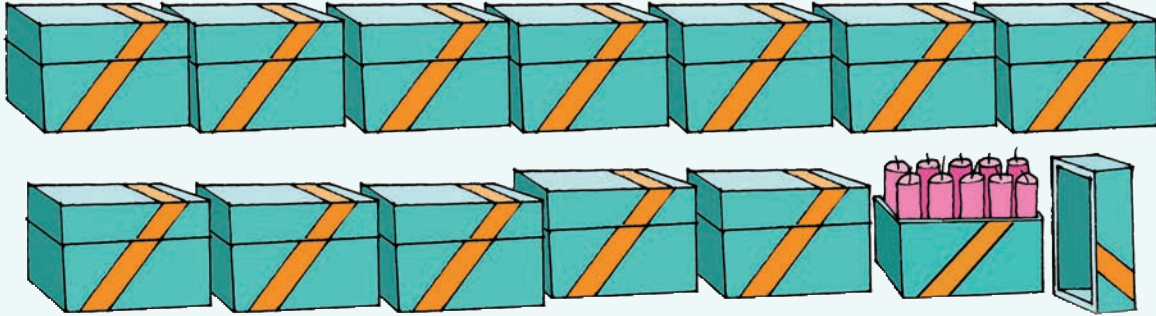

a. Count all the boxes.

How many boxes? _____
How many candles altogether? _____
How many more boxes does she need to fill to have 200 candles? _____

b. How many candles in:

2 boxes? _____	4 boxes? _____
5 boxes? _____	3 boxes? _____
6 boxes? _____	7 boxes? _____

c. How many boxes does she need for:

40  _____ boxes	70  _____ boxes
50  _____ boxes	30  _____ boxes



## Putting tens together and taking them apart



Putting tens together when we add.

<p>Let's add <math>56 + 73 =</math></p>		+	
	5 tens and 6 units		7 tens and 3 units

100s	10s	1s
<p>Together we have 12 tens. We can put 10 tens together to make 1 hundred.</p>		

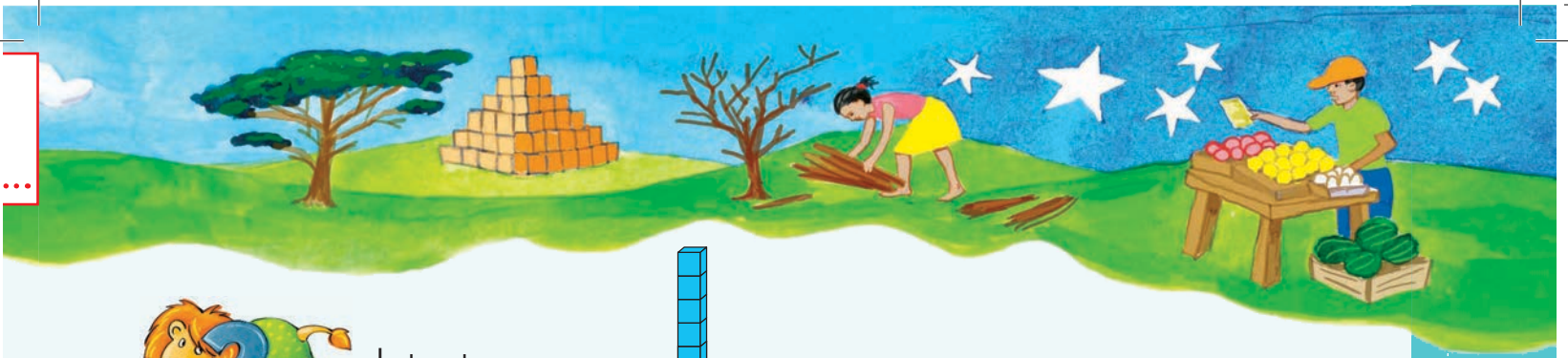

Let us try.



=



and



=

Example:  $82 + 34$

$100 + 20 + 6 = 126$	

a.  $65 + 52$

b.  $76 + 63$

c.  $86 + 65$



Teacher:
Sign:
Date:

## Putting tens together and taking them apart (continued)



Use your place value blocks.

Use base ten blocks to make these two numbers.	All together how many tens? how many units?	Did you group tens or units? Check the place value where you regrouped.	Write the number.
$23 + 99 =$	_____ tens _____ units	11 tens + 12 units = 110 + 12	122
$38 + 25 =$	_____ tens _____ units		
$77 + 31 =$	_____ tens _____ units		
$68 + 45 =$	_____ tens _____ units		
$83 + 47 =$	_____ tens _____ units		



### Taking tens apart when we subtract

When we subtract, we sometimes need to show one ten as ten units, or one hundred as 10 tens.

Let's subtract:  $60 - 55 =$

We start with six tens and no units. We want to subtract five tens and five units.

(The units we are taking away we coloured grey.)

We can show six tens like this.	Or as five tens and ten units.	Take away five tens and five units. Five units are left.	
			$60 - 55 = 5$

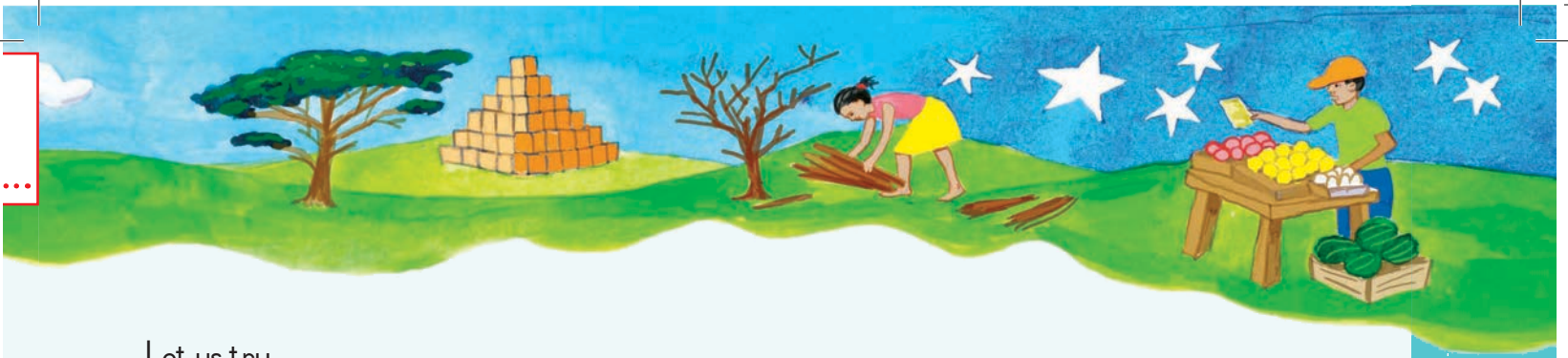

Let us try.

a.  $70 - 28$

7 tens	6 tens and 10 units	$70 - 28 =$	

b.  $90 - 46$

c.  $80 - 53$



Finding the number pair

a.

200	
30	

b.

200	
70	

c.

200	
	105

d.

200	
85	



Teacher: \_\_\_\_\_  
Sign: \_\_\_\_\_  
Date: \_\_\_\_\_

# A visit to the dentist





A group of children visit the dentist.

How many times a day do you brush your teeth?





This is what the children tell him.

 = 1 time

	✓	✓	✓	✓	✓	✓	✓	✓											
	✓	✓	✓	✓	✓	✓	✓	✓	✓	✓	✓	✓	✓	✓	✓	✓	✓	✓	✓
	✓	✓	✓	✓	✓														

a. Count the ticks (✓) showing how often children brush their teeth. Write the numbers.

 Once a day	
 Twice a day	
 Three times a day	

b. What can you see from the table?

Most of the children brush \_\_\_\_\_ a day.

There are \_\_\_\_\_ children in the group.

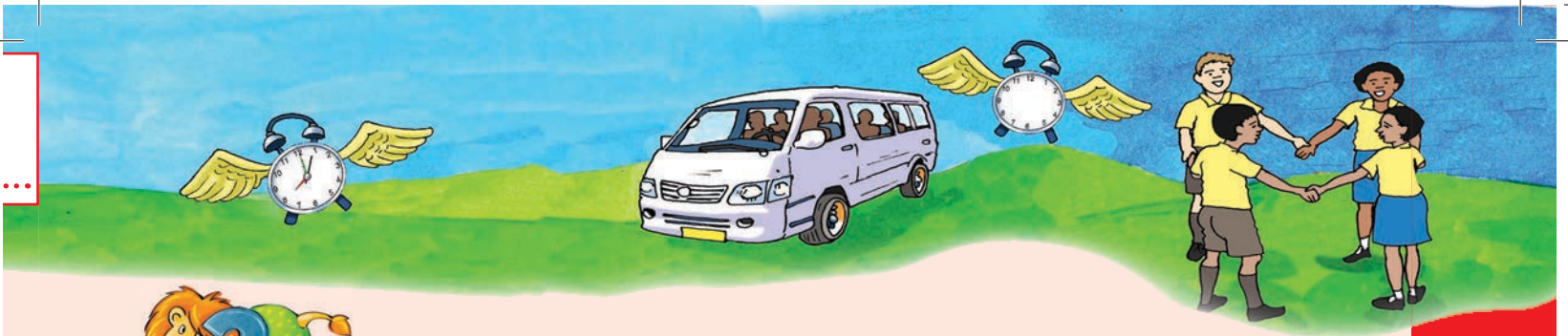

Draw a pictograph of how many times a day the children brush their teeth.



Blank area for drawing a pictograph.



Do a survey in your class. Ask 15–20 learners.

- a. How many times a day they brush their teeth? \_\_\_\_\_
- b. Draw a pictograph like the one above to show your findings.

Teacher: \_\_\_\_\_  
Sign: \_\_\_\_\_  
Date: \_\_\_\_\_

37a

Date: \_\_\_\_\_

## Add and combine

Term 2



## Writing out your sum

Busi can add **units** and **tens** and regroup them. She can add and subtract on paper, without blocks. Sometimes she likes to start with her number cards to show the numbers.

So for the sum  $56 + 73$ , she finds these cards:

$$\begin{array}{|c|c|c|} \hline 5 & 0 & 6 \\ \hline \end{array} + \begin{array}{|c|c|c|} \hline 7 & 0 & 3 \\ \hline \end{array}$$

She adds the units and puts down the 9 card.

9

She knows:  $50 + 70 = 120$ .

She takes the **hundreds**, the 20 and the 9 card to make a 3-digit number.

$$\begin{array}{|c|c|c|} \hline 1 & 0 & 0 \\ \hline \end{array} \begin{array}{|c|c|} \hline 2 & 0 \\ \hline \end{array} \begin{array}{|c|} \hline 9 \\ \hline \end{array}$$

She writes it out like this:

$$\begin{aligned} &50 + 70 + 6 + 3 \\ &= 50 + 70 + 9 \\ &= 120 + 9 \\ &= 100 + 20 + 9 \\ &= 129 \end{aligned}$$



Dumi knows how the blocks work.

She does  $56 + 73$  like this:

$$\begin{array}{r} 50 + 6 + 70 + 3 \\ \swarrow \quad \searrow \\ 120 + 9 \\ = 129 \end{array}$$



Aakar likes to round off.

Here's how he does this one:

$$\begin{aligned} &56 + 73 \\ &= 50 + 70 + 10 - 1 \\ &= 130 - 1 = 129 \end{aligned}$$





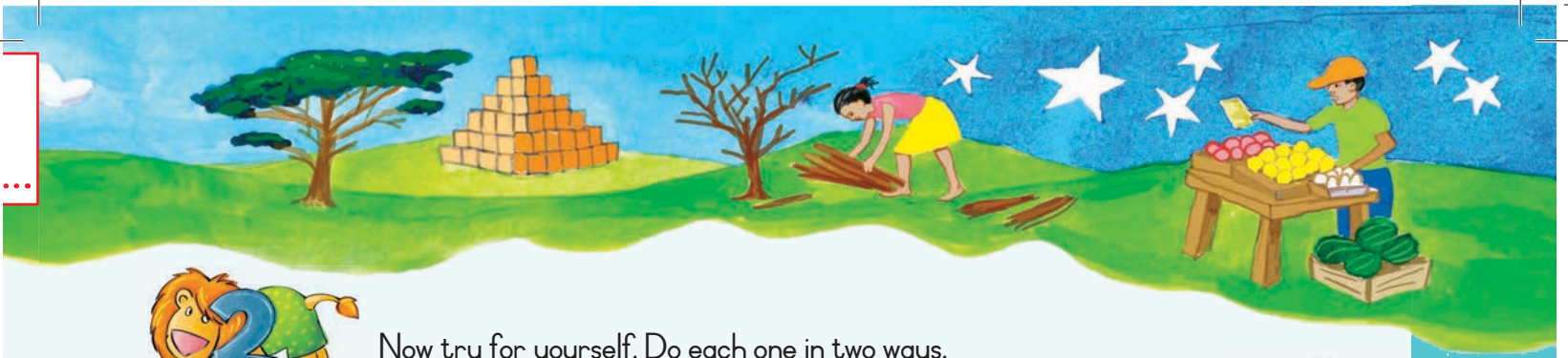

Now try for yourself. Do each one in two ways.

a.  $86 + 62$

Busi's method

$$80 + 60 + 6 + 2$$



Dumi's method

$$80 + 6 + 60 + 2$$



b.  $72 + 63$

c.  $81 + 57$

d.  $69 + 71$

Use Aakar's method to do this one.



Teacher: \_\_\_\_\_

Sign: \_\_\_\_\_

Date: \_\_\_\_\_

## Add and combine (continued)



Now let's subtract.

a.  $87 - 53$

Busi's method

$$\begin{aligned} 80 - 50 + 7 - 3 \\ = 30 + 4 \\ = 34 \end{aligned}$$



Dumi's method

$$\begin{aligned} 80 + 7 - 50 + 3 \\ = 30 + 4 \\ = 34 \end{aligned}$$



b.  $95 - 73$

c.  $86 - 62$

d.  $85 - 69$

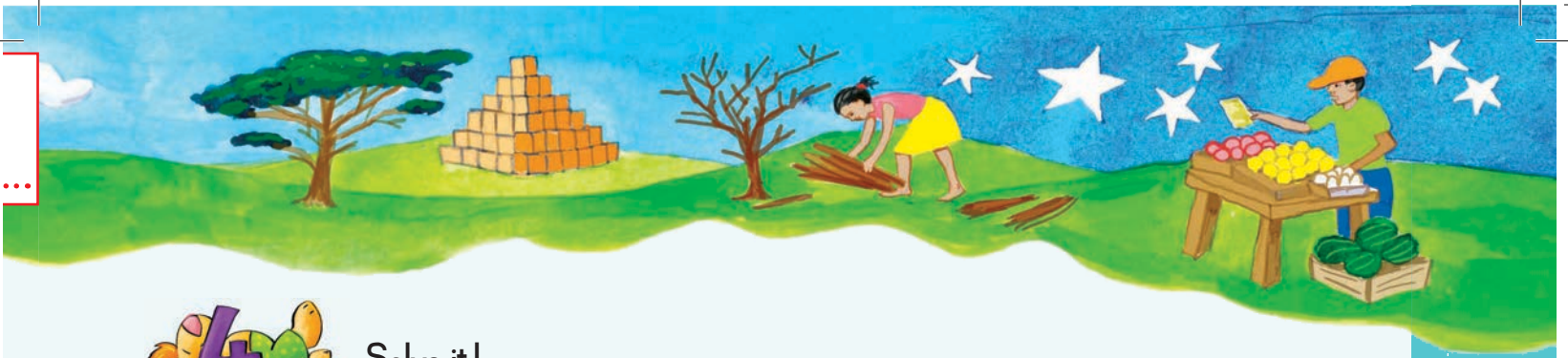

### Solve it!

There are many ways to add **units** and **tens** together. Choose the way you know and like best to solve these problems. Show your work.

- a. Peter first picks 34 peaches and then 67 peaches.  
How many peaches altogether?

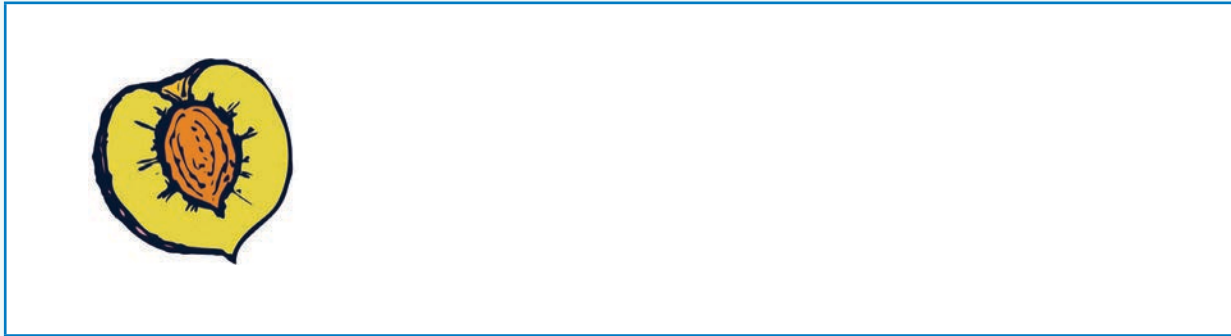

- b. The Malusi kids save R47 together.  
Their mother gives them another R58. How much do they have now?



- c. The school bus travels 88 km in the morning and 73 km in the afternoon.  
How many km altogether?

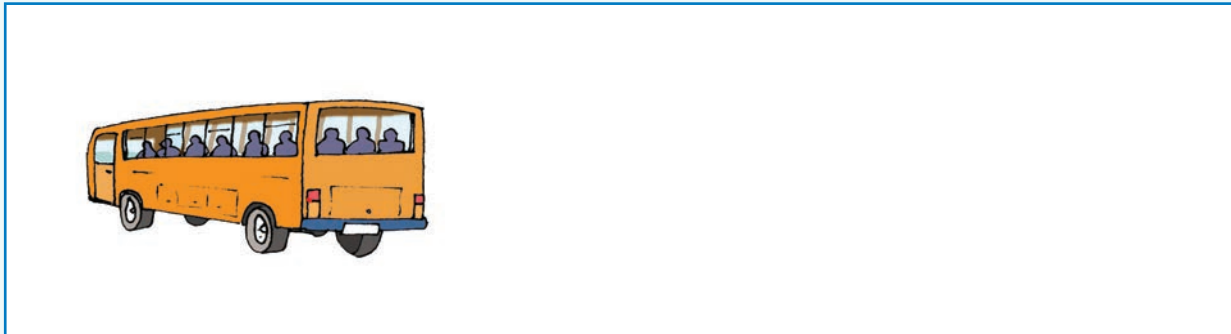

Teacher: \_\_\_\_\_

Sign: \_\_\_\_\_

Date: \_\_\_\_\_

## Solve it!

Use any method you like. Show your work.



## Bottle tops



Sipho



Andile

Sipho counts out 87 bottle tops. Andile counts out 38.  
How many more bottle tops does Sipho count than Andile?



## The school concert



Musa



Musa sells tickets. He had 92 tickets to begin with. He has 67 left.  
How many tickets has Musa sold so far?



### More practice



There are 69 chickens in one pen and 95 in another.  
How many chickens are there altogether?  
Read how Gugu and Aakar solve the problem.

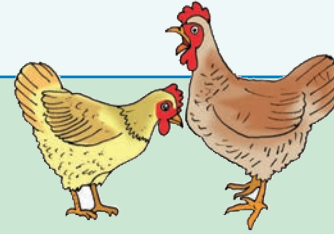

Gugu's way

$$\begin{aligned} &60 + 90 + 9 + 5 \\ &= 100 + 50 + 14 \\ &= 150 + 10 + 4 \\ &= 164 \end{aligned}$$



Aakar's way

$$\begin{aligned} &69 + 95 \\ &= 70 + 95 - 1 \\ &= 70 + 90 + 5 - 1 \\ &= 160 + 4 \\ &= 164 \end{aligned}$$

I subtracted 1.  
Do you know why?



a. The boys collect R96 for a class trip. The girls collect R79.  
How much do they collect altogether?

Use Gugu's way

Use Aakar's way

b. One school collects 76 kg of cans. Another school collects 68 kg cans.  
How many kg of cans do the two schools collect altogether?

Use Gugu's way

Use Aakar's way



Teacher: \_\_\_\_\_  
Sign: \_\_\_\_\_  
Date: \_\_\_\_\_

39

Date:

## Count and calculate

Term 2



### Finding the part

Write in the missing numbers.

a.	<table border="1"><tr><td colspan="2">100</td></tr><tr><td></td><td>27</td></tr></table>	100			27	b.	<table border="1"><tr><td colspan="2">100</td></tr><tr><td>39</td><td></td></tr></table>	100		39		c.	<table border="1"><tr><td colspan="2">100</td></tr><tr><td>43</td><td></td></tr></table>	100		43		d.	<table border="1"><tr><td colspan="2">100</td></tr><tr><td>56</td><td></td></tr></table>	100		56	
100																							
	27																						
100																							
39																							
100																							
43																							
100																							
56																							
e.	<table border="1"><tr><td colspan="2">200</td></tr><tr><td>140</td><td></td></tr></table>	200		140		f.	<table border="1"><tr><td colspan="2">200</td></tr><tr><td></td><td>110</td></tr></table>	200			110	g.	<table border="1"><tr><td colspan="2">200</td></tr><tr><td>135</td><td></td></tr></table>	200		135		h.	<table border="1"><tr><td colspan="2">200</td></tr><tr><td></td><td>120</td></tr></table>	200			120
200																							
140																							
200																							
	110																						
200																							
135																							
200																							
	120																						



### Subtracting back from 220 to 100

Subtract the numbers in the pink box each time.

We have done the first one for you.

220	-15	205	-5		-10	
	-5		-5		-20	
	-10		-15		-10	
	-5		-10		-5	100

Here is a way to check your answers.  
Start at 100. Work back to 220.  
But this time, add the numbers.

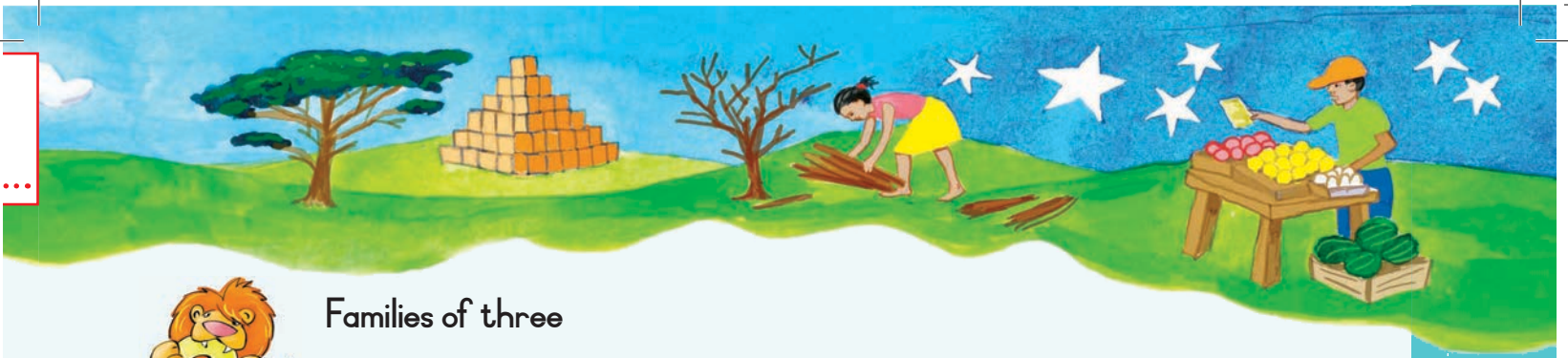

### Families of three

Find 3 numbers that add up to the target number.  
Rule: Only one number can end in 0.

Example:

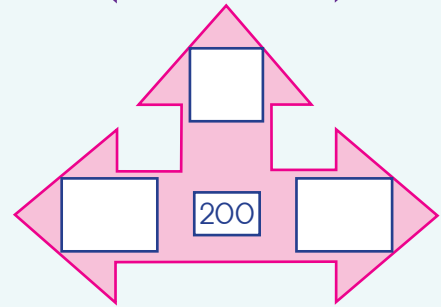
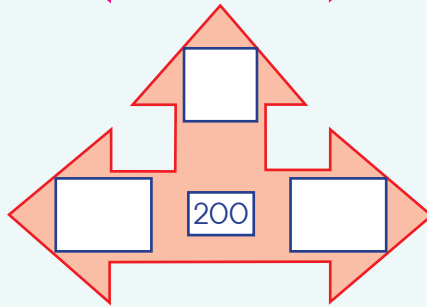
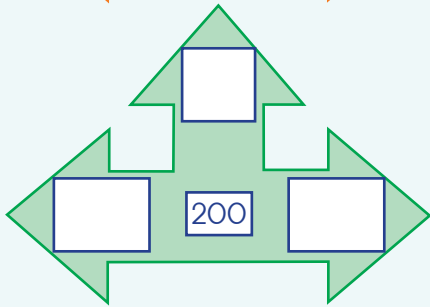
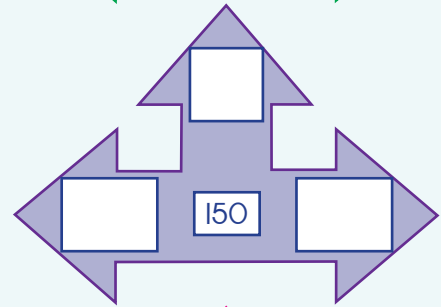
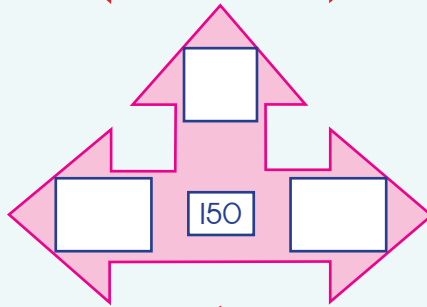
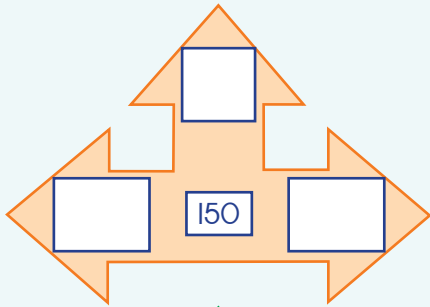
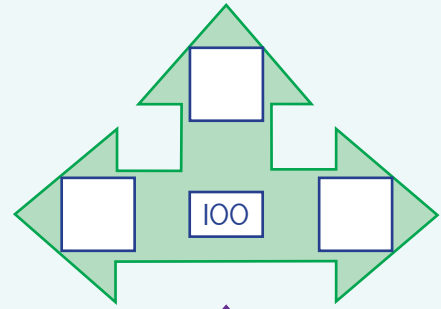
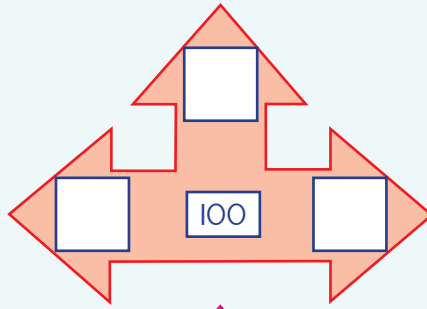
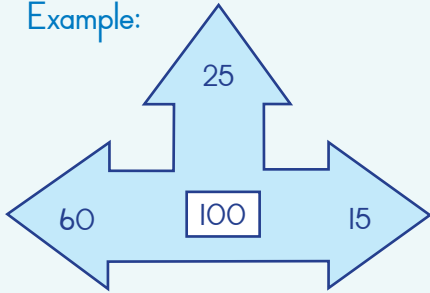

### 50 more and 50 less

Write the answers in the 2nd row.

+50	70	125	150	81	96	122	134	111	70
	120								
-50	186	200	158	179	139	79	126	138	99
	136								



Teacher: \_\_\_\_\_

Sign: \_\_\_\_\_

Date: \_\_\_\_\_

# Measuring in centimetres



How big is a centimetre?



The numbers on the ruler stand for centimetres.

We use the abbreviation or symbol **cm**.

When you use a ruler, you must start to measure from 0.

Some rulers do not show the 0 like the one on this page.

Find zero cm on the ruler. Write 0 on the ruler.

Where is 10 cm on this ruler? Write 10 there.



Estimate, then measure accurately with your ruler, the length in cm of the line making each shape.

a.	b.	c.







a. Estimate <input type="text"/> cm	b. Estimate <input type="text"/> cm	c. Estimate <input type="text"/> cm
Measure <input type="text"/> cm	Measure <input type="text"/> cm	Measure <input type="text"/> cm





How long is each line?

How many cm long is each line?

a. 	<input type="text"/> cm	d. 	<input type="text"/> cm
b. 	<input type="text"/> cm	e. 	<input type="text"/> cm
c. 	<input type="text"/> cm	f. 	<input type="text"/> cm



Are you sure?

Which is longer, the red line or the green line?

How can you check?

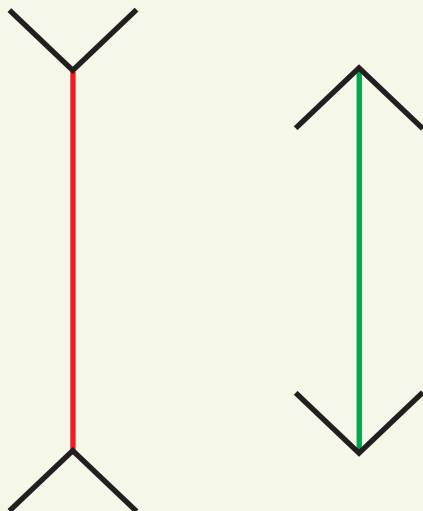

This is what is called an optical illusion. This happens when your eyes are tricked into seeing something that is not really there. The two lines are the same length. The black lines extending outward make the red line look longer and the black lines going inwards make the green line look shorter.



Teacher: \_\_\_\_\_  
 Sign: \_\_\_\_\_  
 Date: \_\_\_\_\_

Date: \_\_\_\_\_

41

Term 2

# Target 300



Counting and writing the 200s

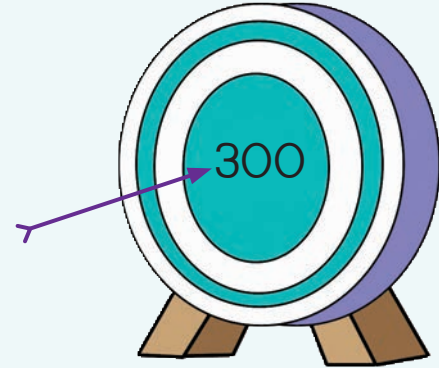

Count from 201 to 300.

Point as you go.

Then fill in the blue numbers first.

Write in the rest of the numbers.



201					207			210
211								
221								
231								
							249	
		254						
			265					
	273							280
281				286				
						298		300

Write the next 10 numbers after 300.

300; \_\_\_\_\_; \_\_\_\_\_; \_\_\_\_\_; \_\_\_\_\_; \_\_\_\_\_; \_\_\_\_\_; \_\_\_\_\_; \_\_\_\_\_; \_\_\_\_\_

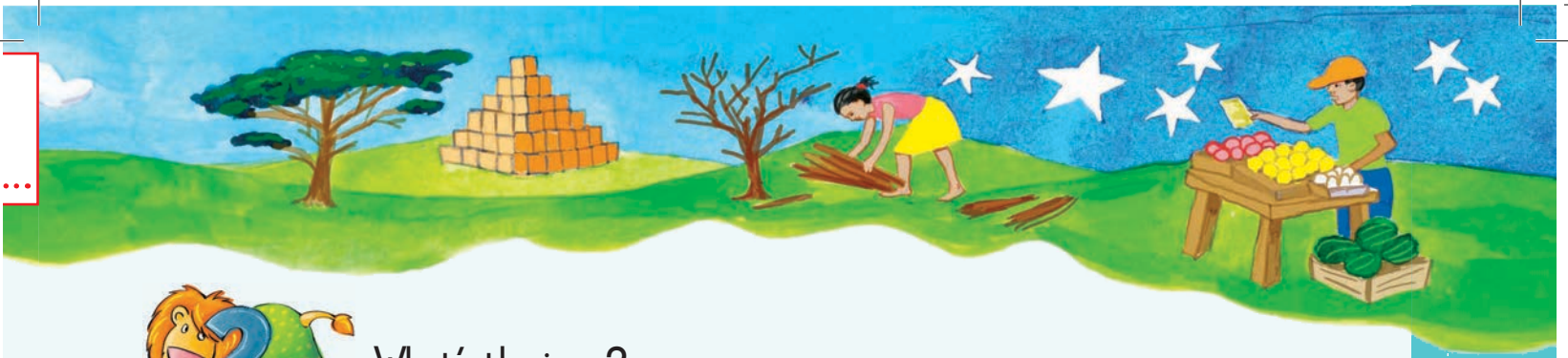

What's the jump?

301		281					
		171				211	
					101		



Showing and comparing

a. Write the numbers that go in each card.

298;	208;	301;	276;	227;	269;	311
200						
90						
8						

b. Write the numbers in order from smallest to biggest.

\_\_\_\_\_ ; \_\_\_\_\_ ; \_\_\_\_\_ ; \_\_\_\_\_ ; \_\_\_\_\_ ; \_\_\_\_\_ ; \_\_\_\_\_



Write the missing numbers.

Start

200	+25	225		237		249

End

300		286		278		261



Teacher: \_\_\_\_\_  
Sign: \_\_\_\_\_  
Date: \_\_\_\_\_

## Adding and subtracting with 100s



Using blocks to add

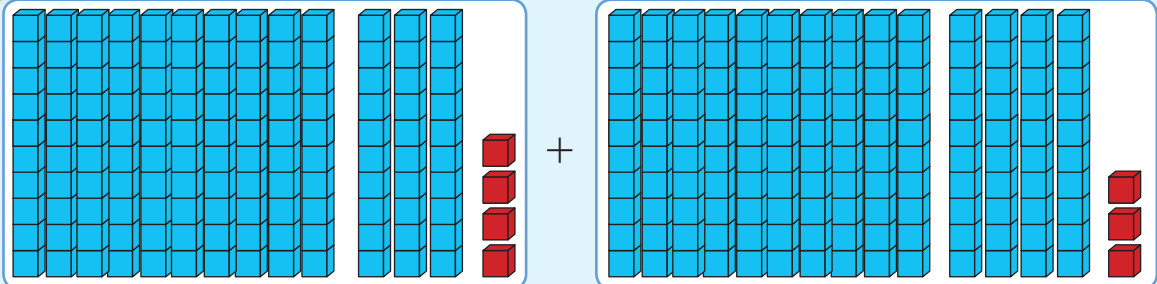

$$\begin{array}{r}
 100 \quad 30 \quad 4 \\
 + \quad 100 \quad 40 \quad 3 \\
 \hline
 = 200 \quad 70 \quad 7 \\
 = 277
 \end{array}$$



Follow the two methods. Show each answer in two ways.

a.  $132 + 123$

Busi's method

$$\begin{aligned}
 &= 100 + 100 + 30 + 20 + 2 + 3 \\
 &= 200 + 50 + 5 \\
 &= 255
 \end{aligned}$$



Dumi's method

$$\begin{aligned}
 &132 + 123 \\
 &= 200 + 50 + 5 \\
 &= 255
 \end{aligned}$$



b.  $114 + 162$

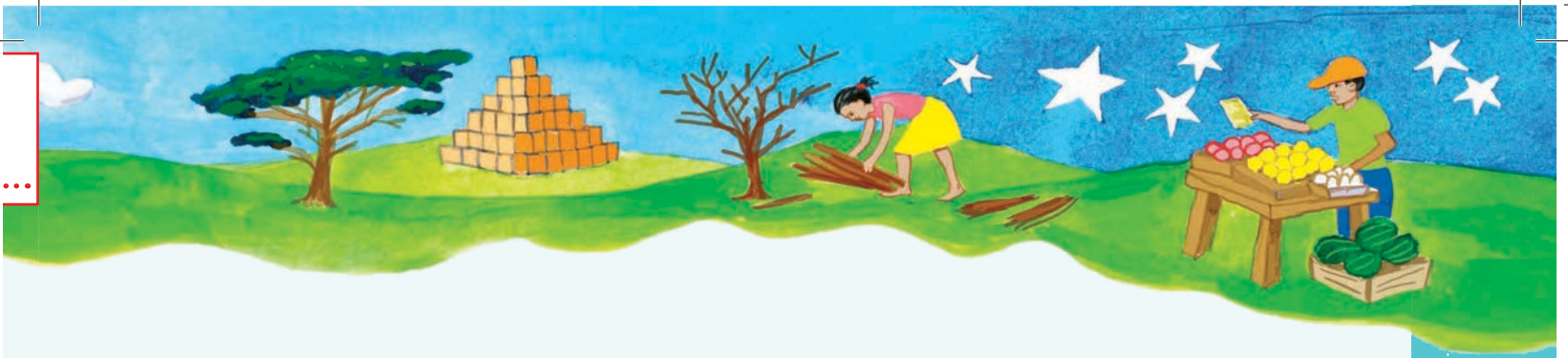

c.  $276 + 148$



Study each method. Work out each sum in two ways.

a.  $158 - 146$

Busi's method

$$= 100 - 100 + 50 - 40 + 8 - 6$$

$$= 0 + 10 + 2$$

$$= 12$$



Dumi's method

$$158 - 146$$

$$= 0 + 10 + 2$$

$$= 12$$



b.  $194 - 122$

c.  $288 - 199$



Teacher: \_\_\_\_\_

Sign: \_\_\_\_\_

Date: \_\_\_\_\_

Date: \_\_\_\_\_

43

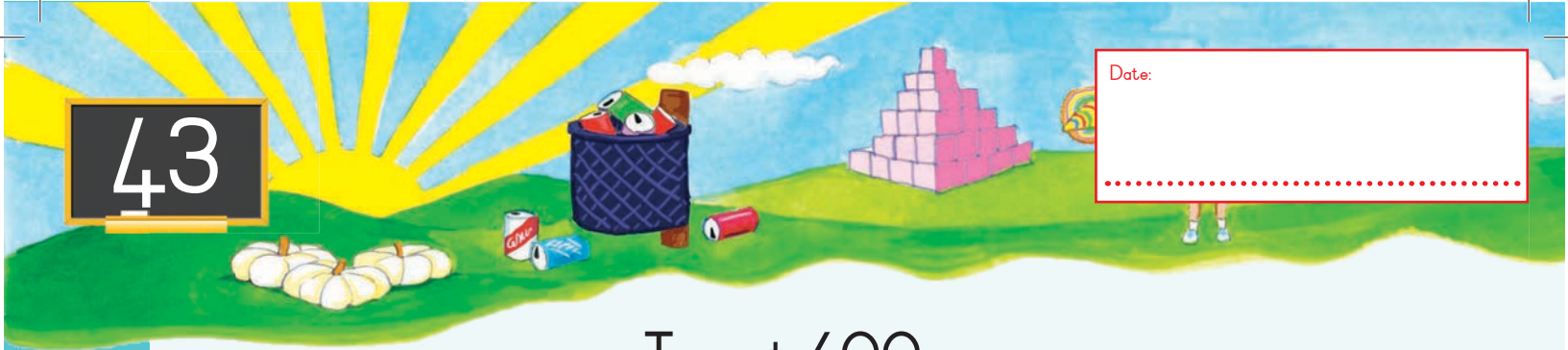

Term 2

# Target 400



## Counting and writing the 400s

Count on from 300 to 400.

Say the numbers as you go.

Write the missing numbers on the grid.

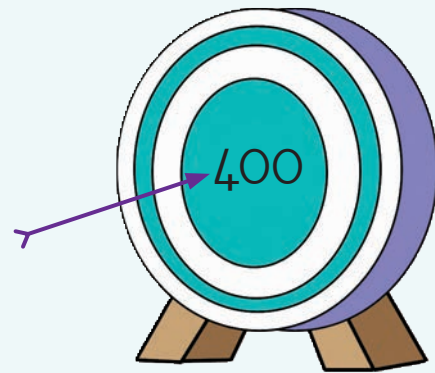

301									310
			315						
									330
331			335						
							249		
			365			368			
		273							
									390
									400

Write the next 9 numbers after 400.

400; \_\_\_\_\_; \_\_\_\_\_; \_\_\_\_\_; \_\_\_\_\_; \_\_\_\_\_; \_\_\_\_\_; \_\_\_\_\_; \_\_\_\_\_; \_\_\_\_\_;



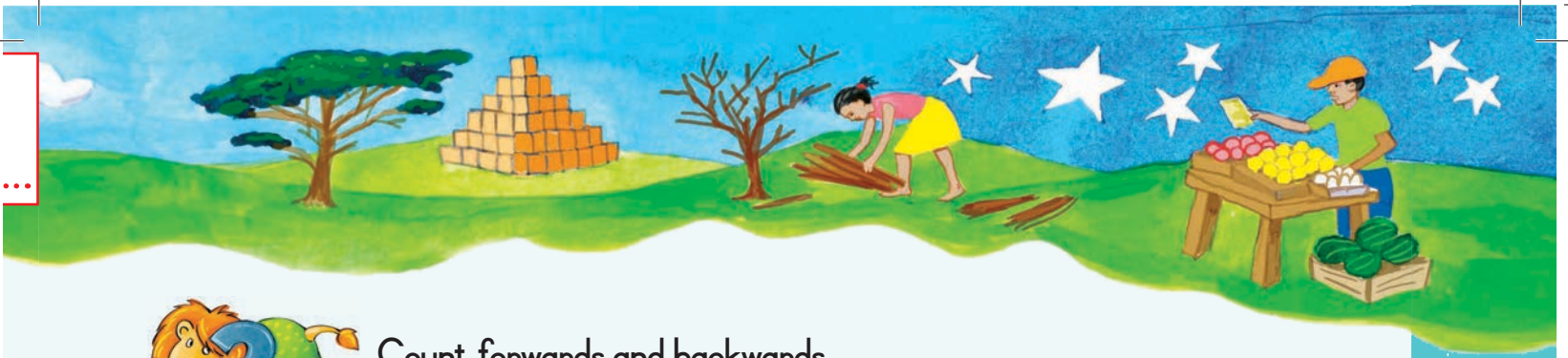

## Count forwards and backwards

a. Counting forward from 300 in tens.

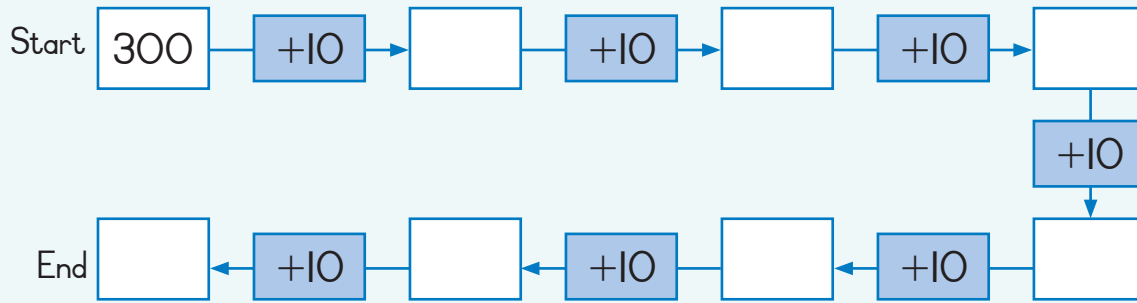

b. Count back from 400 in tens.

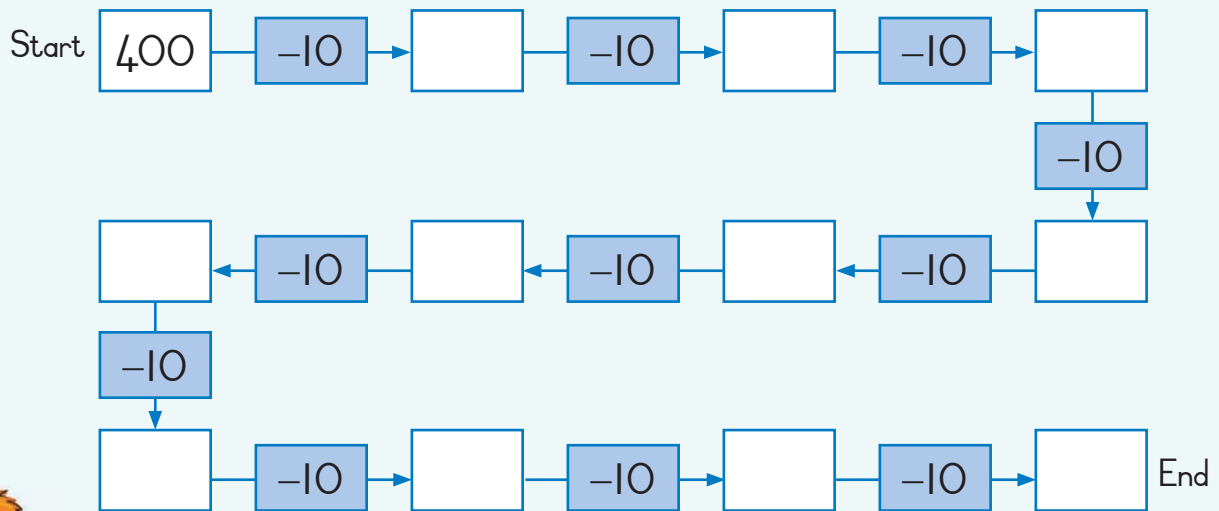

## Write as one number

$300 + 20 + 4 = \underline{\hspace{2cm}}$

$300 + 50 + 3 = \underline{\hspace{2cm}}$

$300 + 60 + 2 = \underline{\hspace{2cm}}$

$300 + 80 + 1 = \underline{\hspace{2cm}}$

$300 + 10 + 5 = \underline{\hspace{2cm}}$

$300 + 70 + 7 = \underline{\hspace{2cm}}$

$300 + 90 + 9 = \underline{\hspace{2cm}}$

$300 + 40 + 8 = \underline{\hspace{2cm}}$

Write the answers in order from smallest to biggest.

\_\_\_\_\_

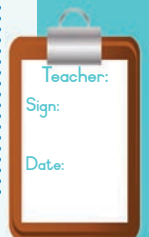

44

Date:

Term 2

## Weighing in



Add some kilograms.

Add and write the answers.

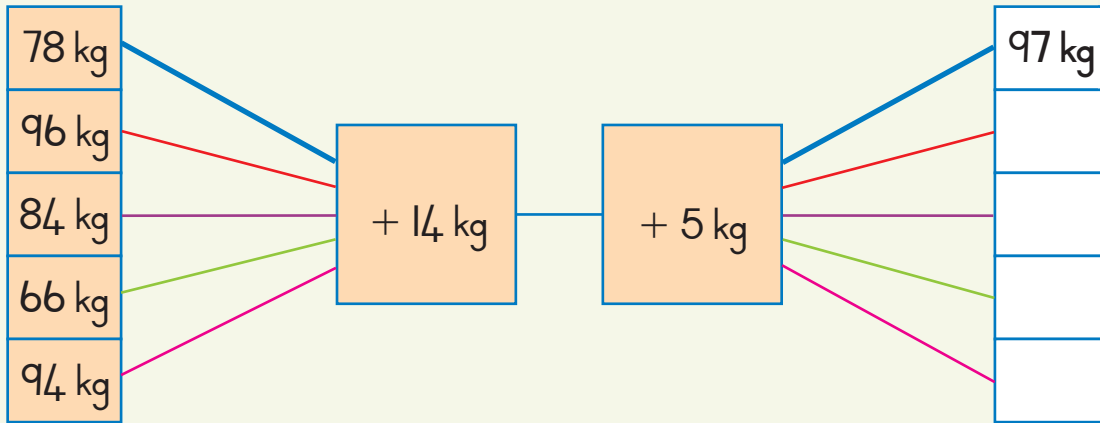

## Rounding off and adding!

Think smart!

				
Jackal 25 kg	Tortoise 98 kg	Baboon 59 kg	Baby zebra 88 kg	Pelican 9 kg

Round off the mass of each animal to the nearest 10 kg.

---

Write the mass of each animal in order from light to heavy.

---

Estimate the total mass of the 5 animals.

---



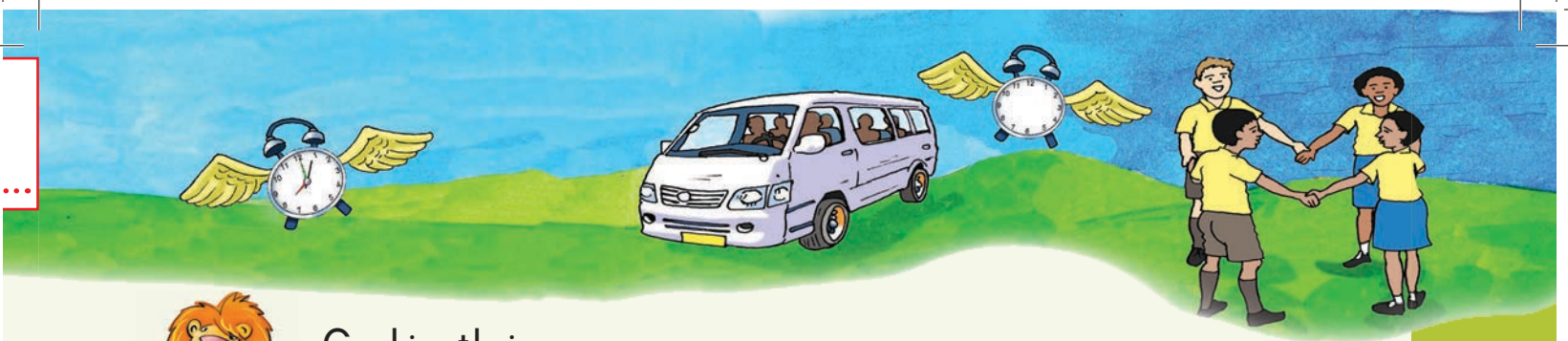

### Combine their mass











I may not be as heavy as you, old Tortoise, but I sure am faster!



#### Steps



- Use your rounded off amounts to estimate.
- Estimate the mass of the animals in each row.
- Calculate the totals using the actual mass.
- Compare the two totals and write the difference.

	I estimate	I calculate	The difference
 + 			
 +  + 			
 +  + 			



### Vusi's mass

Check. Compare. Correct.

Vusi adds his own mass to the mass of  and .

Their total mass is 239 kg. How much does Vusi weigh? Show your answer.



### What's my weight?

Play in a group. Take turns ...

Add your mass to the mass of some of the animals. Work out the total. Tell the answer to the group. Don't show them your work! They must then try and work out your mass.





Teacher: \_\_\_\_\_

Sign: \_\_\_\_\_

Date: \_\_\_\_\_

45

Date: \_\_\_\_\_

Term 2



# Target 500

Counting and writing

400

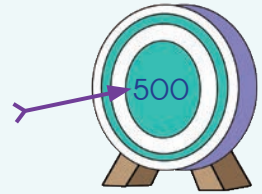

401				405					410
411									420
	422					427			
			434						
					446				
							458		
	462								470
		473				477			
481									490
								499	500

- Count on from 400. Say the numbers as you go.
- Write the missing numbers in the grid.
- Write the next 9 numbers after 500.

500; \_\_\_\_\_; \_\_\_\_\_; \_\_\_\_\_; \_\_\_\_\_; \_\_\_\_\_; \_\_\_\_\_; \_\_\_\_\_; \_\_\_\_\_

- Count in 2s. Write the next 8 numbers in the **2s pattern**.

400; 402; \_\_\_\_\_; \_\_\_\_\_; \_\_\_\_\_; \_\_\_\_\_; \_\_\_\_\_; \_\_\_\_\_; \_\_\_\_\_

- Count in 5s. Write the next 8 numbers in the **5s pattern**.

400; 405; \_\_\_\_\_; \_\_\_\_\_; \_\_\_\_\_; \_\_\_\_\_; \_\_\_\_\_; \_\_\_\_\_; \_\_\_\_\_

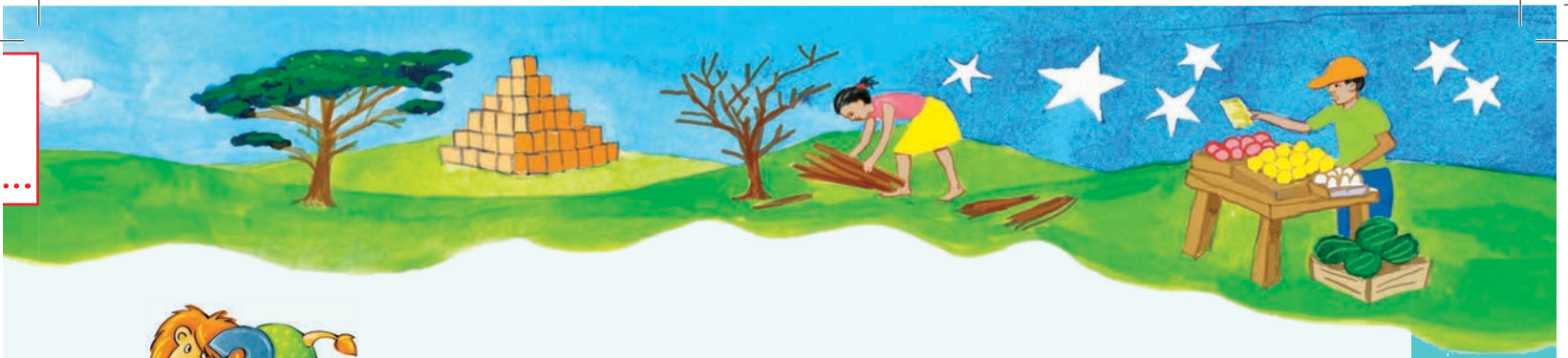

Fill in the missing numbers.

a. Add forward from 400.

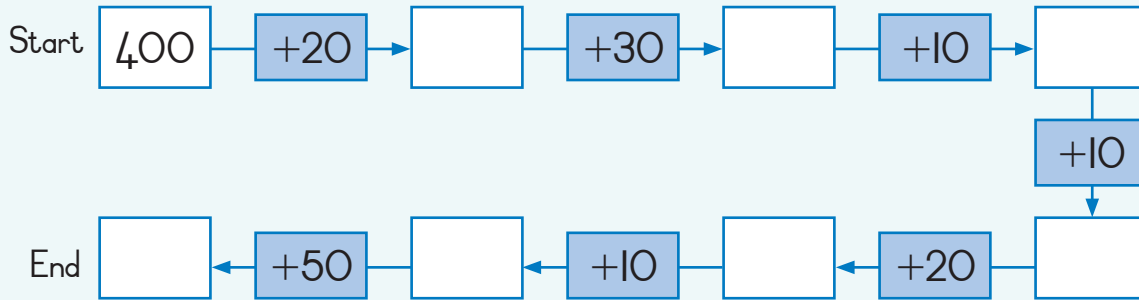

b. Count back from 500.

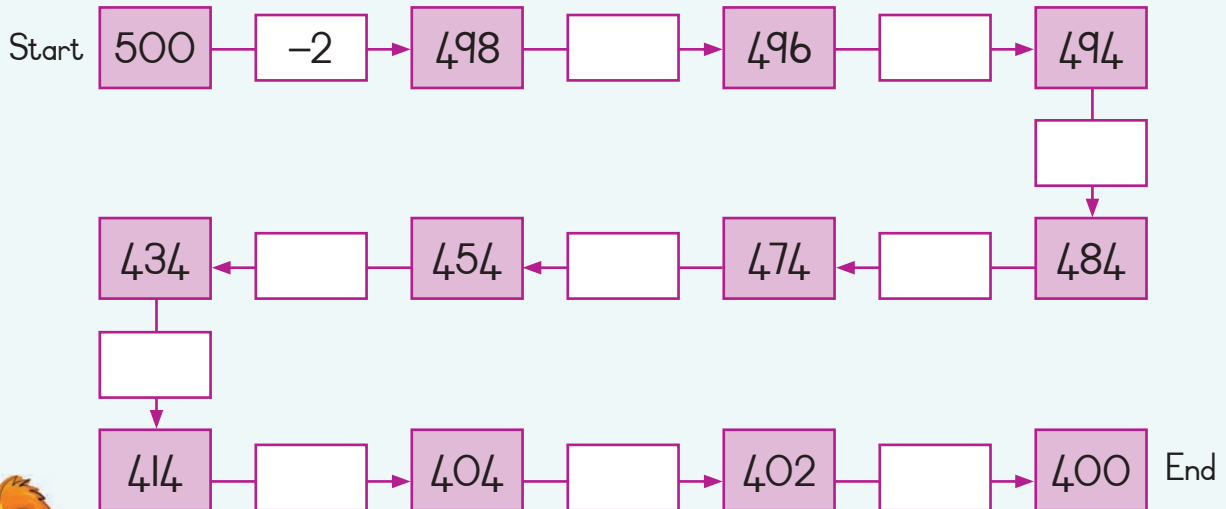

Showing the numbers. Follow the example.

Find the totals. Use your number cards to show each total.

$405 + 10$	415	$400 + 10 + 5$	$398 + 10$		
$446 + 10$			$424 + 10$		
$455 + 10$			$460 + 20$		



46

Date:

## More adding and subtracting

Term 2

$\begin{array}{r} 200 \\ 200 \\ + 50 \\ + 30 \\ + 4 \\ + 5 \\ \hline \end{array}$	$\begin{array}{r} 400 \\ + 80 \\ + 9 \\ \hline \end{array}$	$489$
---	---	-------



You are going to use Busi's and Dumi's methods again to add.

a.  $245 + 231$

Busi's method

$$\begin{aligned} &= 200 + 200 + 40 + 30 + 5 + 1 \\ &= 400 + 70 + 6 \\ &= 476 \end{aligned}$$



Dumi's method

$$\begin{array}{r} 245 + 231 \\ \hline \end{array}$$

*(Diagram showing lines connecting 200 to 400, 40 to 70, and 5+1 to 6)*

$$\begin{aligned} &= 400 + 70 + 6 \\ &= 476 \end{aligned}$$



b.  $278 + 136$

c.  $265 + 148$

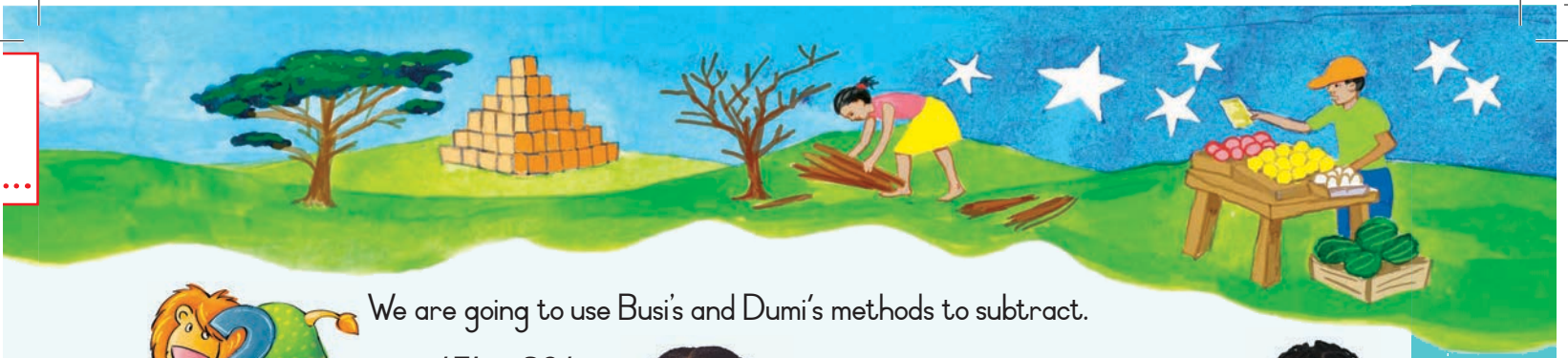

We are going to use Busi's and Dumi's methods to subtract.

a.  $476 - 324$

Busi's method

$$= 400 - 300 + 70 - 20 + 6 - 4$$

$$= 100 + 50 + 2$$

$$= 152$$



Dumi's method

$$476 - 324$$

$$= 100 + 50 + 2$$

$$= 152$$



b.  $489 - 456$

c.  $482 - 161$



Reaching the target

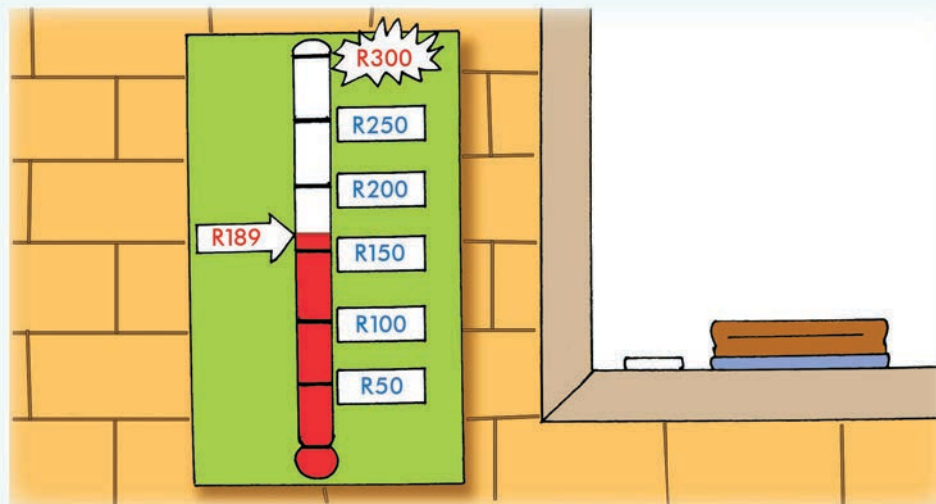

Study the picture.

How much more to reach the target?

R

Teacher: \_\_\_\_\_  
 Sign: \_\_\_\_\_  
 Date: \_\_\_\_\_

Date:

47

# Sharpen your skills

Term 2



## Secret mountain

What's the name of the highest mountain in Gauteng? Use the code to find out. Match each answer in the table to a letter in the code.

A	B	C	D	E	F	G	H	I	J	K	L	M
1	2	3	4	5	6	7	8	9	10	11	12	13
N	O	P	Q	R	S	T	U	V	W	X	Y	Z
14	15	16	17	18	19	20	21	22	23	24	25	26

Number clues	Answer	Letter
Example: $2 \times 3 \times 3 \times 1 = \square$	18	R
$50 + 50 + 50 + 100 - 200 - 45 = \square$		
$1 + 2 + 7 + 10 + 7 + 1 - 14 = \square$		
$60 - 30 + 50 + 20 - 50 - 15 - 20 = \square$		
$3 + 2 + 7 + 1 + 2 + 1 + 3 = \square$		
$5 + 3 + 30 = 4 + 2 + 12 + \square$		
$100 - 5 - 70 = 20 + \square$		
$36 + 44 - 60 - 2 = \square$		
$10 + 15 = 14 + \square$		
$2 + 1 + 14 + 9 + 14 = 25 + \square$		
$1 \times 2 \times 2 \times 2 \times 2 = \square$		

The mountain's name is



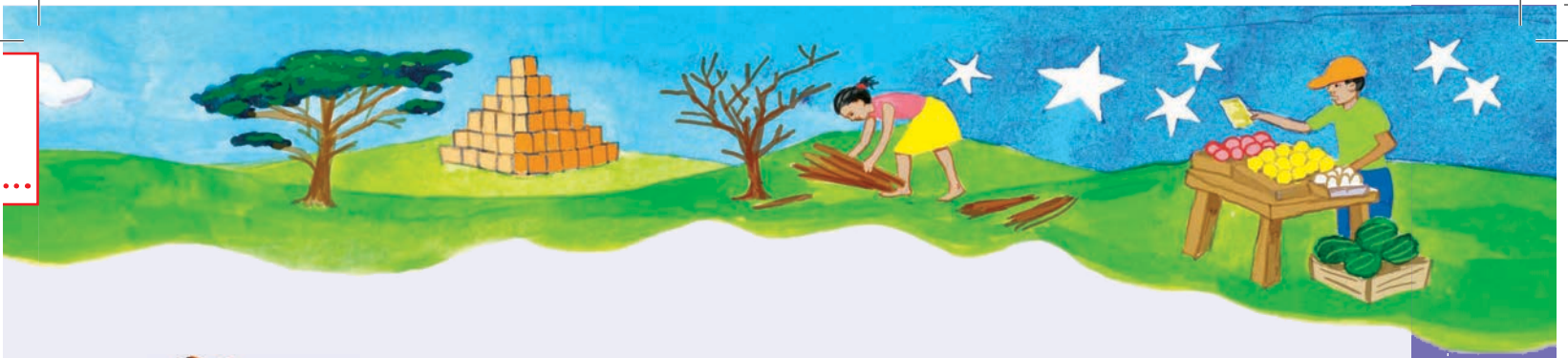

Look, think and answer!

\*  \*  \*  \*  \*     
  \*  \*  \*  \*  \*     
  \*  \*  \*  \*  \*

1   2   3   4   5                     
 6   7   8   9   10                     
 11   12   13   14   15

- a.
- |   |                         |                         |                         |
|---|-------------------------|-------------------------|-------------------------|
| What shape will number 16 be? Tick (✓) the right one. | <input type="radio"/> * | <input type="radio"/> * | <input type="radio"/> * |
| What shape will number 18 be? Tick (✓) the right one. | <input type="radio"/> * | <input type="radio"/> * | <input type="radio"/> * |
| What shape will number 23 be? Tick (✓) the right one. | <input type="radio"/> * | <input type="radio"/> * | <input type="radio"/> * |

- b.
- |                         |                |
|-------------------------|----------------|
| Number 50 will be a *.  | True or False? |
| Number 100 will be a ●. | True or False? |
| Number 28 will be a ◐.  | True or False? |



Check. Compare. Correct.

Which is more?

To get **R2,50 a day** pocket money for June and July.

Or to get **R150** total pocket money for the two months?

Show how you worked it out.

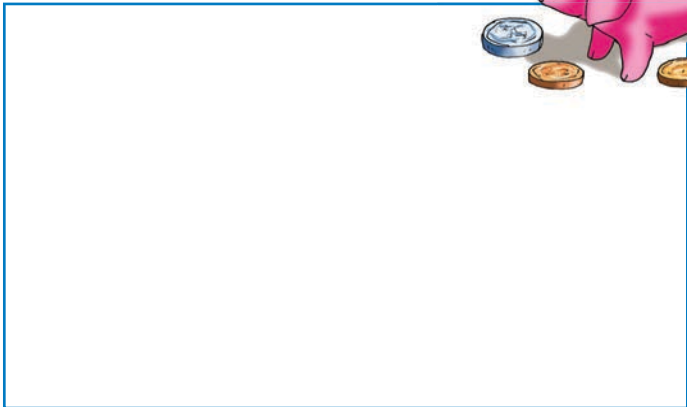

Teacher: \_\_\_\_\_  
 Sign: \_\_\_\_\_  
 Date: \_\_\_\_\_

11   12   13   14   15   16   17   18   19   20

# Symmetry

What do you notice about these shapes?

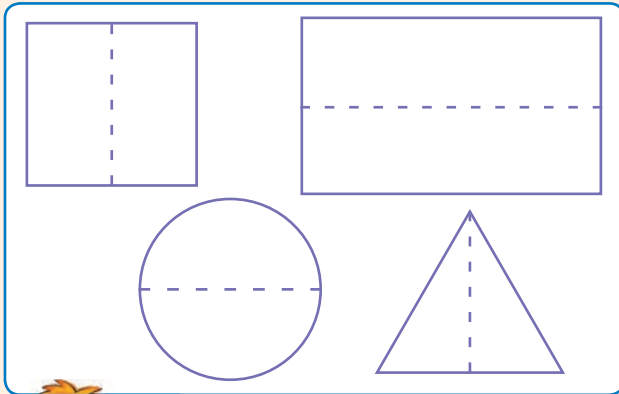

A line of symmetry divides a shape into two halves so that each half is a mirror-image of the other.

A shape has symmetry if you can fold it along the line of symmetry so that the two halves match exactly.



Draw a line of symmetry for each shape.

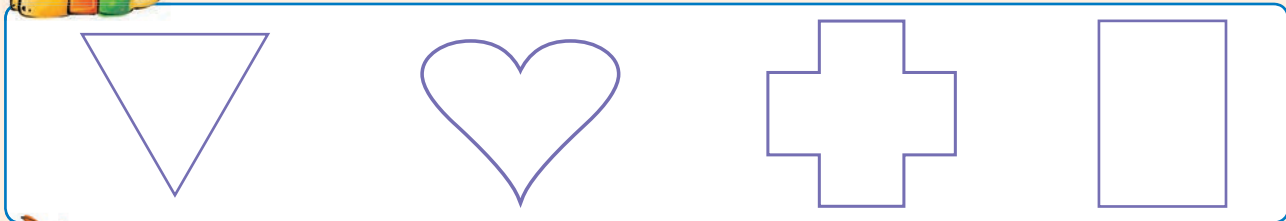

Is the dotted line a line of symmetry or not. Circle the (Y) Yes or (N) No.

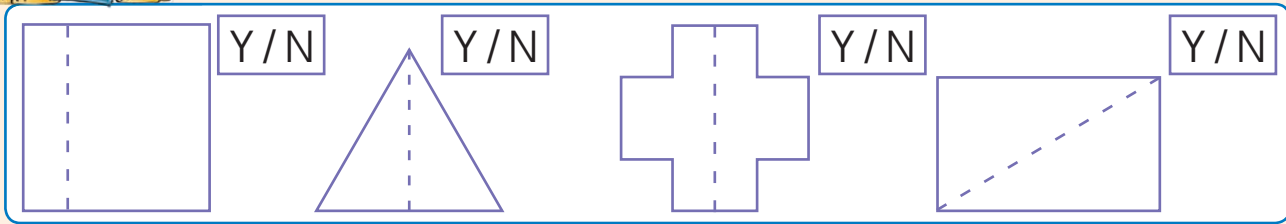

Is this a line of symmetry? Why?

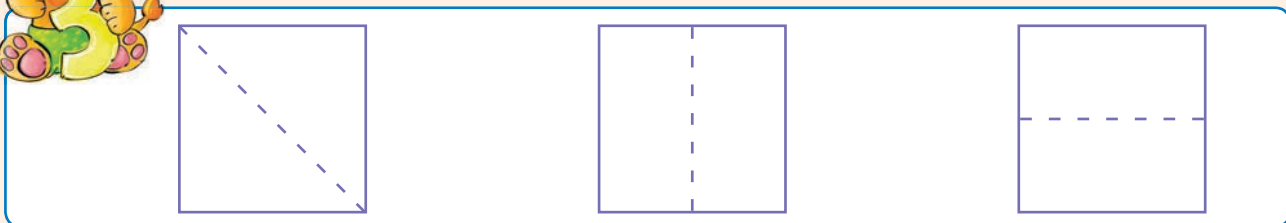



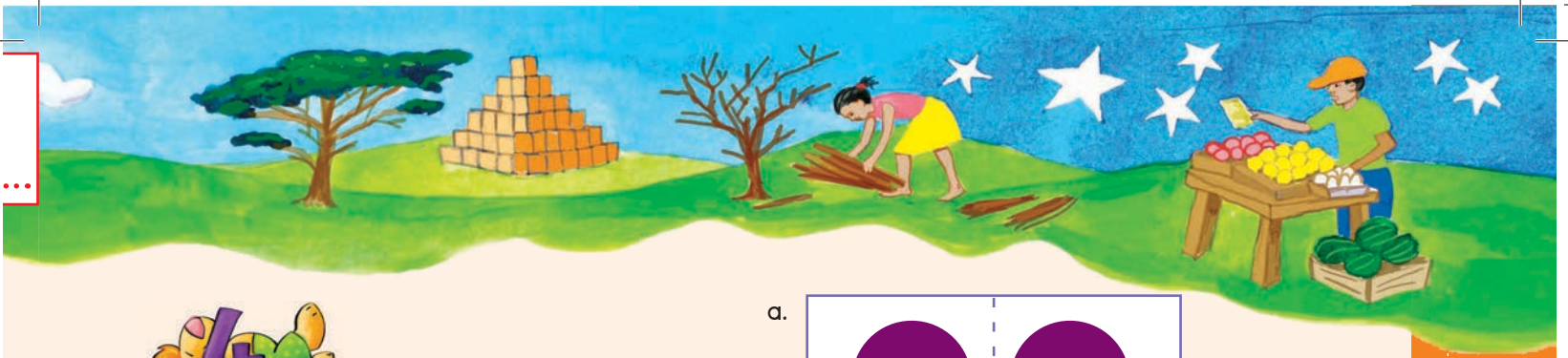

Draw shapes to make the picture symmetrical.

We have done the first one for you.

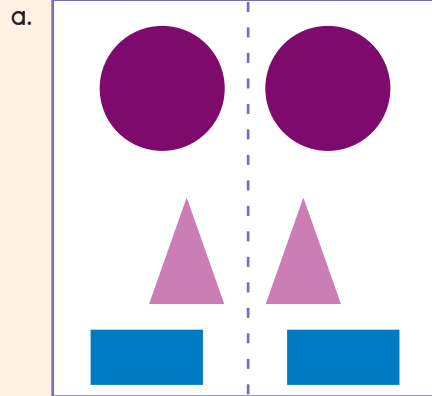

b.

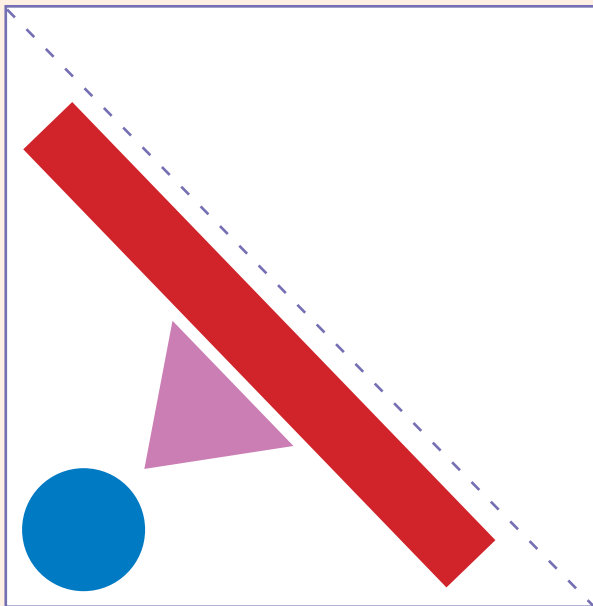

c.

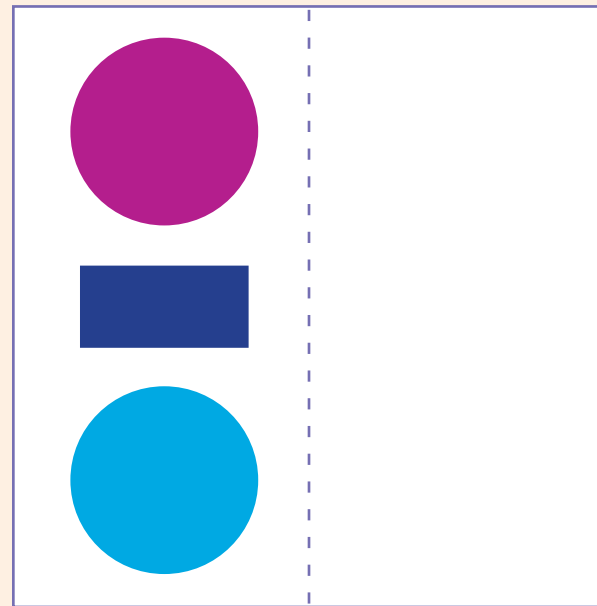

Create your own symmetrical carpet using shapes.

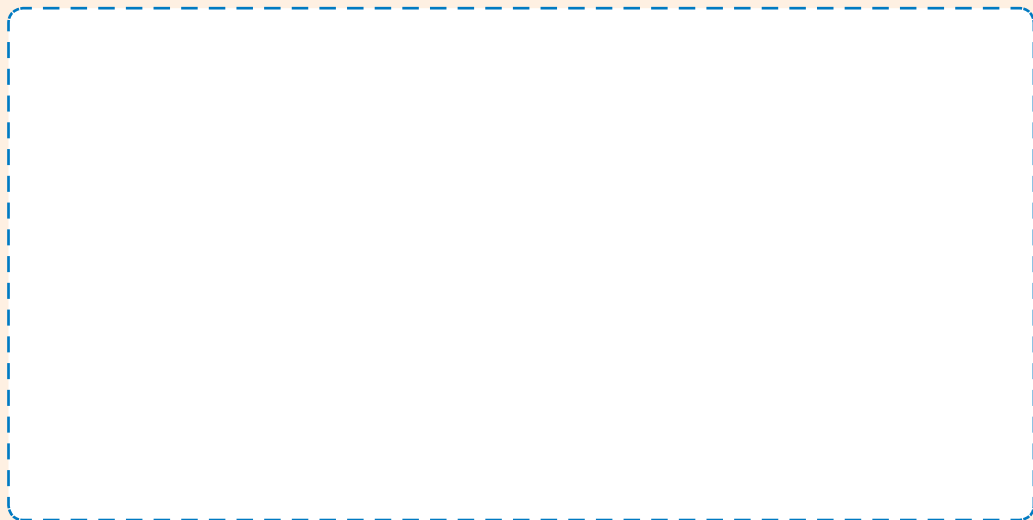

Date: \_\_\_\_\_

49

# Building up to 500

Term 2



Counting the apples.

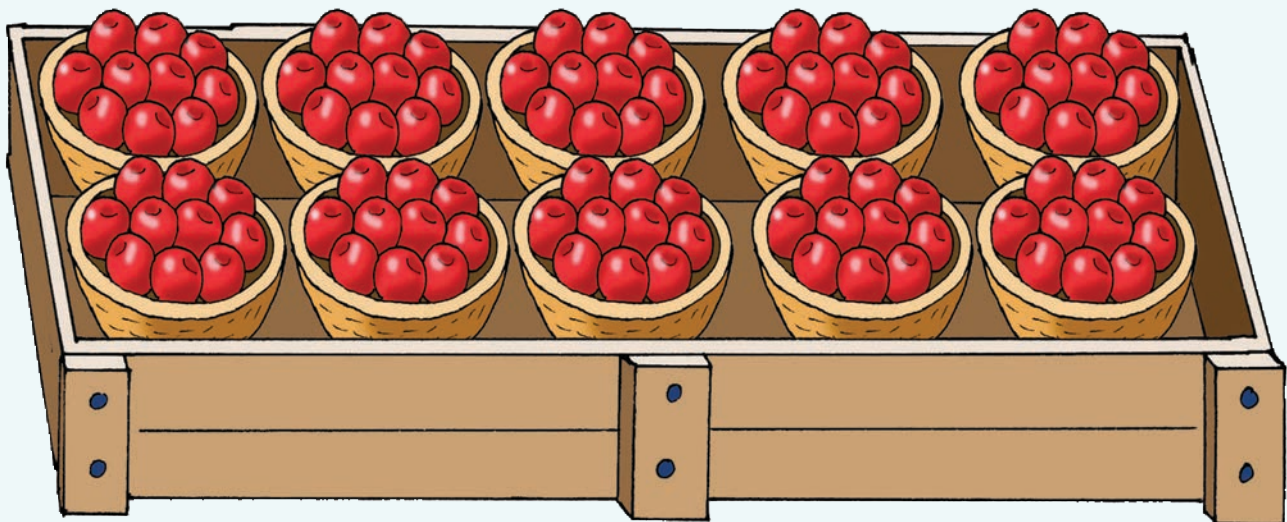
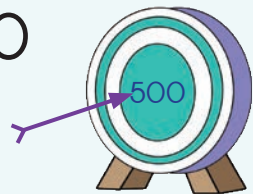

Complete and multiply

1 basket holds _____ apples.	$1 \times 10 = 10$
3 baskets hold _____ apples.	$3 \times 10 =$
5 baskets hold _____ apples.	
4 baskets hold _____ apples.	
2 baskets hold _____ apples.	
1 crate holds 100 apples.	2 crates hold _____ apples.
3 crates hold _____ apples.	4 crates hold _____ apples.
5 crates hold _____ apples.	2 half crates hold _____ apples.



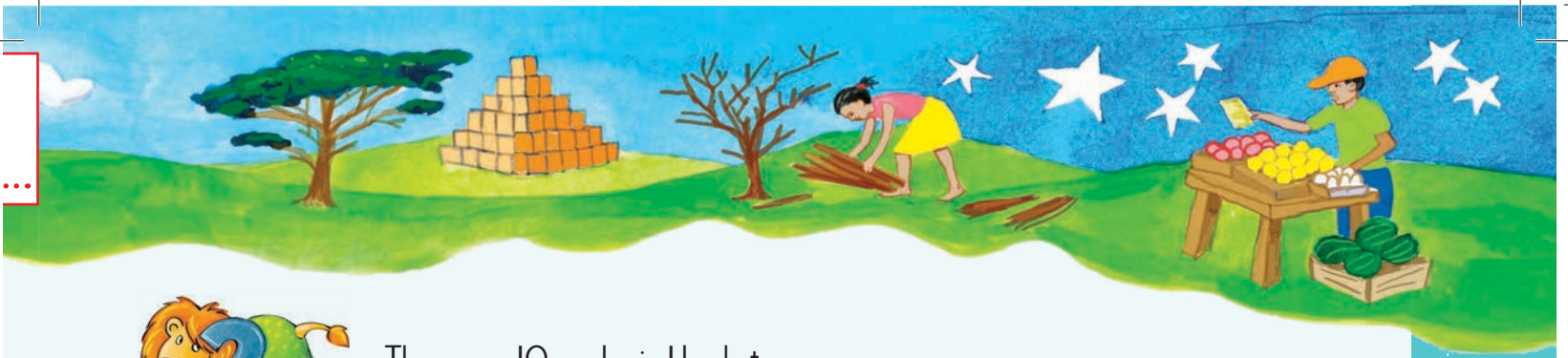

There are 10 apples in 1 basket.

There are \_\_\_\_\_ baskets in one crate.

There are \_\_\_\_\_ apples in one crate.

How many apples are there altogether? \_\_\_\_\_

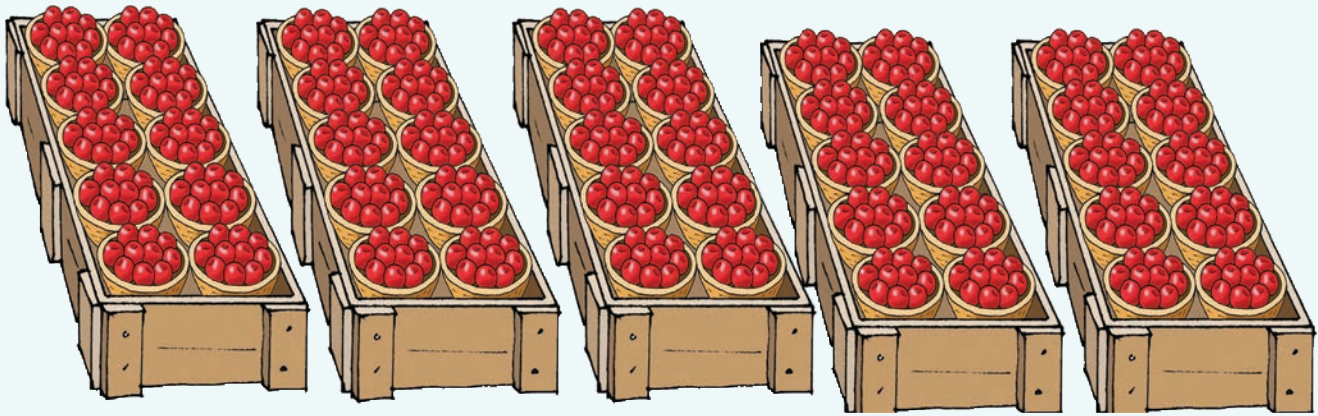

Calculating, showing and writing

300

40

5

First use number cards to show each total. Then write in the number.

3 crates  + 4 baskets  + 5 apples  = 345 apples

4 crates  + 5 baskets  + 7 apples  = \_\_\_\_\_ apples

5 crates  + 2 baskets  + 3 apples  = \_\_\_\_\_ apples

4 crates  + 7 baskets  + 2 apples  = \_\_\_\_\_ apples



11 12 13 14 15 16 17 18 19 20

## Multiplication and division (10)





Counting the apples.

Fill in the table.

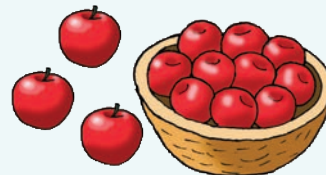
How many baskets hold the apples?



Apples 	10	20	30	40	50
Baskets 	1	2			

÷ sum					$50 \div 10 = 5$
× sum					$5 \times 10 = 50$



Divide the apples between the children. Make a drawing.

Write a division and multiplication sum to check your answer.

a.

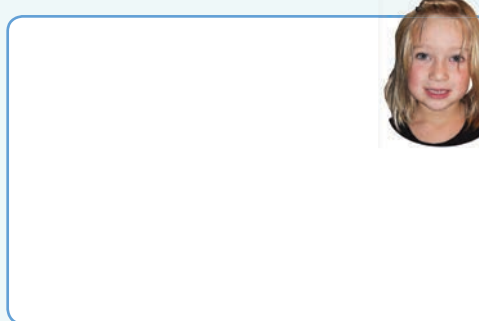
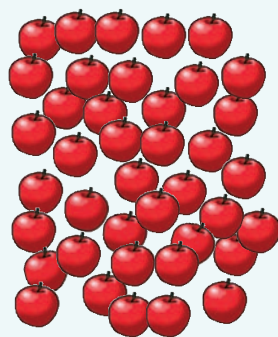

Check your answers

÷  =

×  =





b.

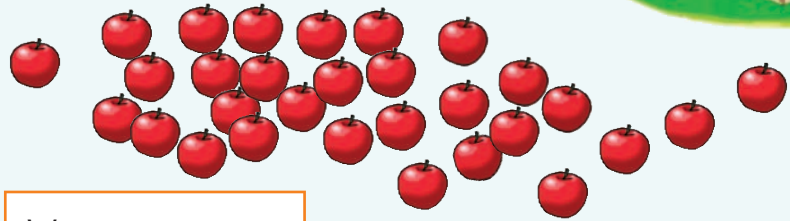

Write a  $\div$  sum

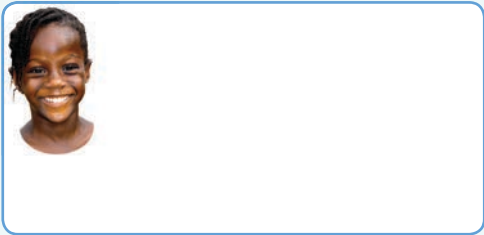

Write a  $\times$  sum to  
check your answers

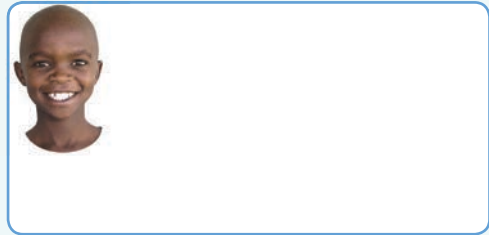

Use the numbers to make your own number sentences.

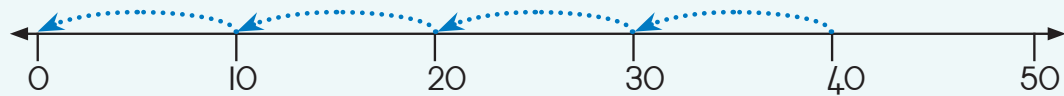

Example

$$\div \quad 40 \div 10 = 4$$

$$\times \quad 4 \times 10 = 40$$

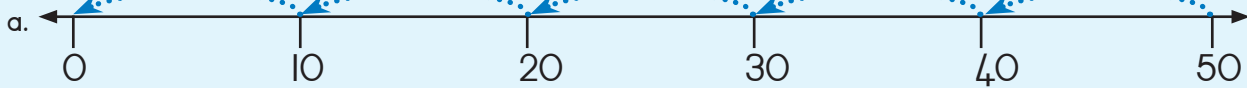

$$\div \quad \boxed{\phantom{000}} \div \boxed{\phantom{000}} = \boxed{\phantom{000}}$$

$$\times \quad \boxed{\phantom{000}} \times \boxed{\phantom{000}} = \boxed{\phantom{000}}$$

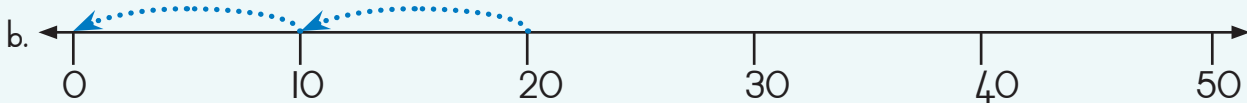

$$\div \quad \boxed{\phantom{000}} \div \boxed{\phantom{000}} = \boxed{\phantom{000}}$$

$$\times \quad \boxed{\phantom{000}} \times \boxed{\phantom{000}} = \boxed{\phantom{000}}$$



$$\div \quad \boxed{\phantom{000}} \div \boxed{\phantom{000}} = \boxed{\phantom{000}}$$

$$\times \quad \boxed{\phantom{000}} \times \boxed{\phantom{000}} = \boxed{\phantom{000}}$$



Write a number 10 smaller and 10 bigger than the given number.

_____, 460, _____	_____, 390, _____	_____, 500, _____
-------------------	-------------------	-------------------

Teacher: \_\_\_\_\_

Sign: \_\_\_\_\_

Date: \_\_\_\_\_





## Count in 2s

Counting forwards and backwards in 2s

- a. 232; 234; \_\_\_\_\_; \_\_\_\_\_; \_\_\_\_\_; 242; \_\_\_\_\_; \_\_\_\_\_; 248
- b. 500; \_\_\_\_\_; 496; \_\_\_\_\_; \_\_\_\_\_; 490; \_\_\_\_\_; \_\_\_\_\_; \_\_\_\_\_
- c. 460; \_\_\_\_\_; \_\_\_\_\_; 400; \_\_\_\_\_; 360; \_\_\_\_\_; \_\_\_\_\_; \_\_\_\_\_
- d. 341; \_\_\_\_\_; 361; \_\_\_\_\_; \_\_\_\_\_; 391; \_\_\_\_\_; 411; \_\_\_\_\_; \_\_\_\_\_



Pairs of gloves



- a. How many **pairs of gloves** in one row? \_\_\_\_\_
- b. How many **single gloves** in one row? \_\_\_\_\_
- c. How many rows? \_\_\_\_\_
- d. How many gloves altogether? \_\_\_\_\_
- e. Show how you work it out.
- f. Write your answer as a number sentence.  
 \_\_\_\_\_  $\times$  \_\_\_\_\_ = \_\_\_\_\_

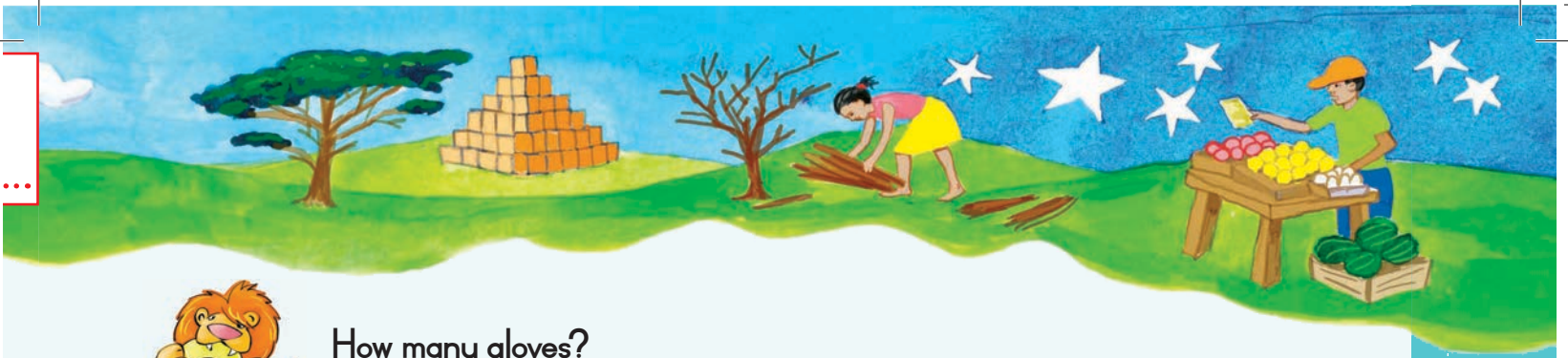

How many gloves?

Write in the tables.

a.

Pair of gloves										
Number of gloves	2									

b.

Single gloves	20	21	70	73
Pairs that can be made				
Single gloves left over				



Count in twos

a. Which number comes in between?

264, _____, 268	391, _____, 395	414, _____, 410
-----------------	-----------------	-----------------

b. Write the next two numbers.

373, 375, <u>377</u> , 379	480, 482, _____, _____	262, 264, _____, _____
----------------------------	------------------------	------------------------

c. Write the next two numbers.

346, 348, _____, _____	415, 417, _____, _____	297, 299, _____, _____
------------------------	------------------------	------------------------





## Planning a garden



Mrs Mabena has some pretty tiles.

She uses them to pave an area in her garden.

There are 6 square tiles of the same size.

How shall I place them?

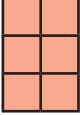

I can make 1 row with 6 tiles.	I can make 2 rows with 3 tiles in a row.	I can make 3 rows with 2 tiles in each row.
		
$6 \times 1 = 6$	$3 \times 2 = 6$	$2 \times 3 = 6$

## Now it's your turn!

Shade blocks to show how you can arrange 8 and 9 square tiles.

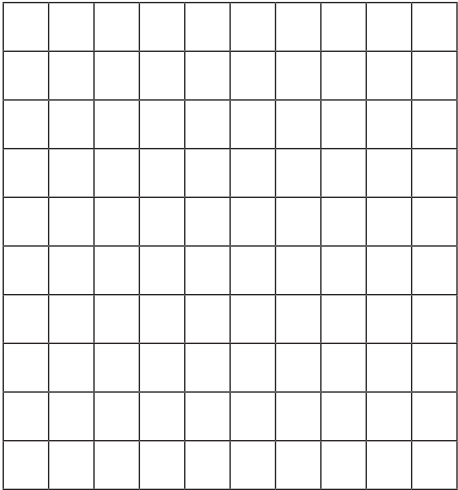
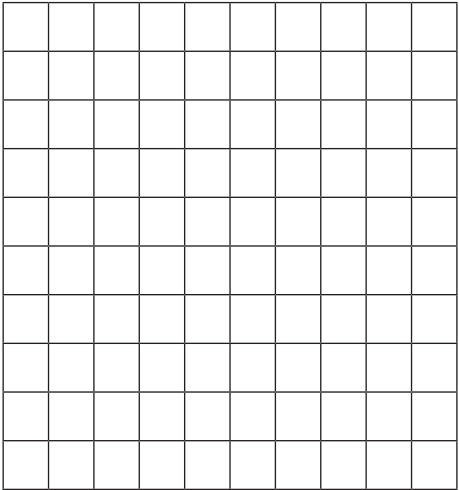
8 squares	9 squares
	

Write number sentences for each drawing.



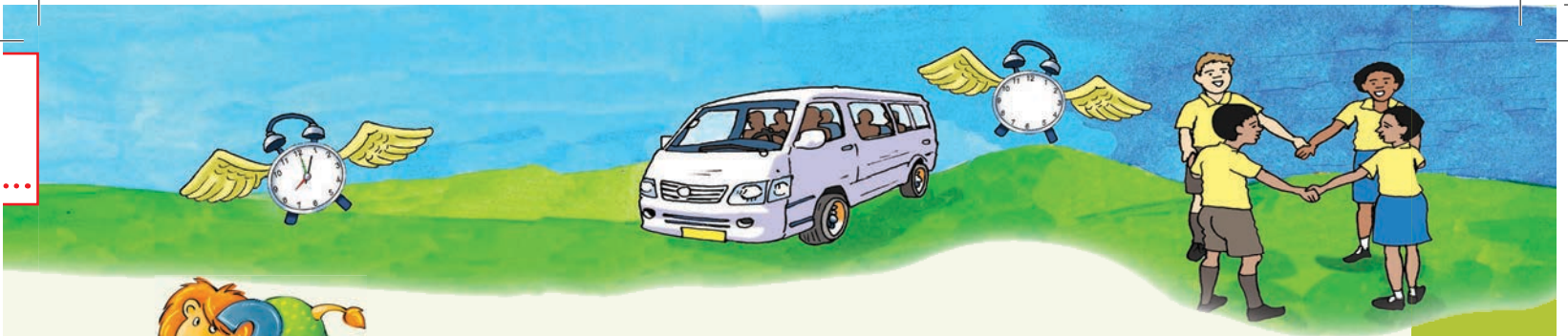

### Arrange 12 tiles

Thabo has 12 square tiles to pave next to the house. Help him find all the ways he can do this.

Write a number sentence for each way.

<p>Example:</p>	$1 \times 12 = 12$ $12 \times 1 = 12$



### Arrange 24 tiles

- Use the grid in Cut-out sheet 2.
- Shade 24 blocks in different ways.
- Write number sentences to match each drawing.



### I can multiply!

$12 = 2 \times \square$	$3 \times \square = 12$	$9 = \square \times 3$
$6 = 3 \times \square$	$\square \times 3 = 12$	$24 = 3 \times \square$

Teacher:

Sign:

Date:

## Using fives



## Knowing your 5s

Fill in the answers.

	1	2	3	4	5	6	7	8	9	10
$\times 5$	5									



## Counting the candles

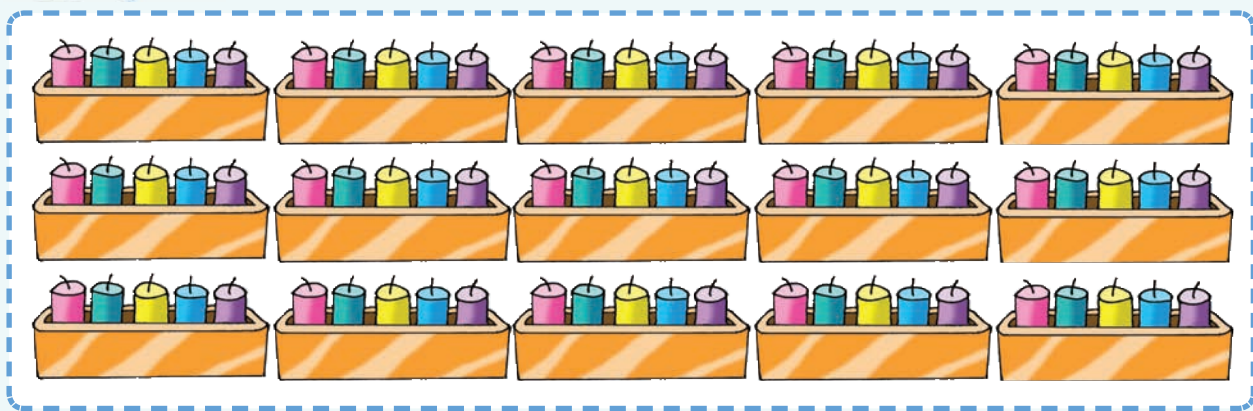

- a. How many **candles** in each **box**? \_\_\_\_\_
- b. How many **boxes** in each row? \_\_\_\_\_
- c. How many **candles** in each row? \_\_\_\_\_
- d. How many **candles** altogether? \_\_\_\_\_



## Showing the answer

Tick (✓) the number sentences that show the total number of candles.

a.  $5 \times 3 \times 3 = \square$    b.  $15 \times 3 = \square$    c.  $3 \times 5 \times 5 = \square$    d.  $15 \times 5 = \square$



## Counting forwards and backwards in 5s

- a. 85; \_\_\_\_\_; \_\_\_\_\_; 70; \_\_\_\_\_; \_\_\_\_\_; 55; \_\_\_\_\_; \_\_\_\_\_
- b. 240; \_\_\_\_\_; \_\_\_\_\_; 255; \_\_\_\_\_; \_\_\_\_\_; \_\_\_\_\_; \_\_\_\_\_; 280
- c. 405; \_\_\_\_\_; 395; \_\_\_\_\_; \_\_\_\_\_; 380; \_\_\_\_\_; \_\_\_\_\_; 365; \_\_\_\_\_



## Collecting R5 coins

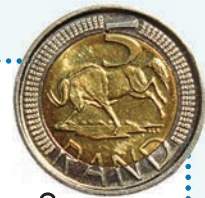

The children collect R5 coins. How many R5 coins do they need to collect to have R \_\_\_?  
We have done the first two for you.

R5 ÷ R5 = 1 coin	R10 ÷ R5 = 2 coins	R15? _____	R20? _____	R25? _____
R30? _____	R35? _____	R40? _____	R45? _____	R50? _____

$2 \times R5 = R$

$4 \times R5 = R$

$3 \times R5 = R$

$6 \times R5 = R$

Do you see the pattern?



## Multiplying by 5s

Example:  $1 \times 5 = 5$ ;  $11 \times 5 = 55$ ;  $21 \times 5 = 105$

Think smart! Build on facts you know!

1	2	3	4	5	6	7	8	9	10
5	10								
11	12	13	14	15	16	17	18	19	20
55									



Teacher: \_\_\_\_\_

Sign: \_\_\_\_\_

Date: \_\_\_\_\_

11 12 13 14 15 16 17 18 19 20



Date: .....

### Working with time



#### Drawing the times

	Quarter past 12		4:30
	Quarter to eleven		6:15
	Half past 5		12:45



#### Time problem

Nomsa's mom leaves home at 2:30.  
She comes back at 5:15.  
How long is she out for?

We can use a time line to work it out.  
Put your finger on 2:30,  
the time it is now.

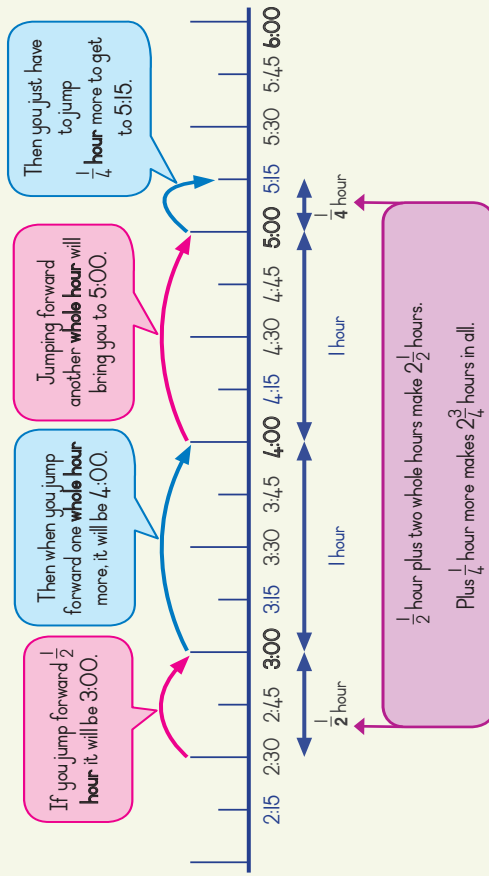

#### Time problems

Check. Compare. Correct.

Solve each problem. Use the time lines to help you.

a. Queenie visits her Dad at the clinic at 15:45.



She leaves at 17:15.

How long does she visit for?



b. Musa goes to the park at 10:45.



He comes home at 12:30.

How long is he away for?



c. Tumi starts to study at 13:15.



She finishes at 14:45.

How long does Tumi study for?



Teacher: \_\_\_\_\_  
Sign: \_\_\_\_\_  
Date: \_\_\_\_\_



Date: .....

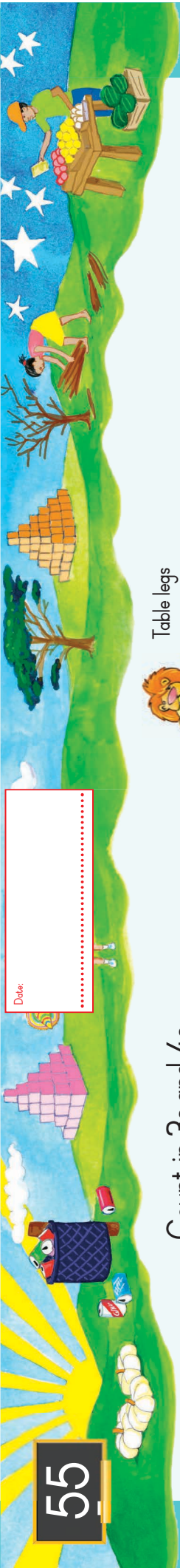

Count in 3s and 4s

Pots with 3 legs

Add and write the answers.

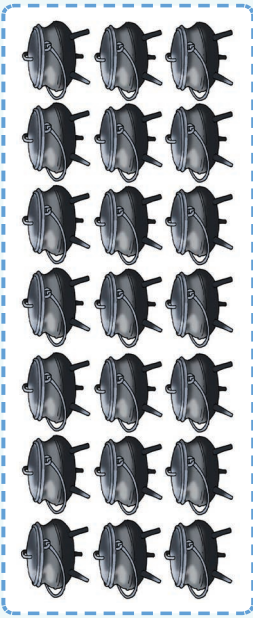

- a. How many pots in a row? \_\_\_\_\_
- b. How many legs in a row? \_\_\_\_\_
- c. How many rows of pots? \_\_\_\_\_
- d. How many legs altogether? Show how you work it out.

Tick (✓) which number sentences below show the total.

$21 \times 7 = \square$     $3 \times 7 \times 3 = \square$     $3 \times 4 \times 2 = \square$     $21 \times 3 = \square$



How many legs?

Think fast.  
Think smart.

1 pot	3 legs	10 pots	legs	5 pots	legs
2 pots	legs	15 pots	legs	12 pots	legs
5 pots	legs	13 pots	legs	14 pots	legs



Table legs

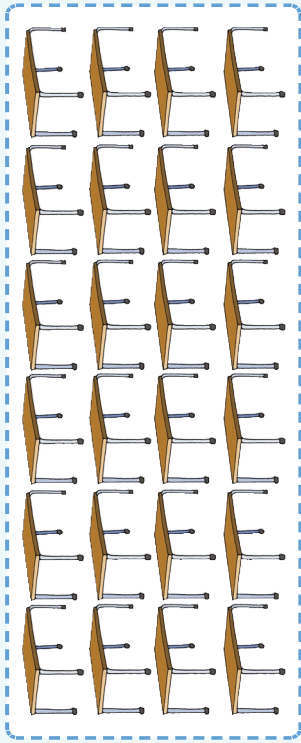

- a. How many tables in a row? \_\_\_\_\_
- b. How many legs in a row? \_\_\_\_\_
- c. How many rows of tables? \_\_\_\_\_
- d. How many legs altogether? Show how you work it out.



At the factory

A carpenter makes tables. He first makes the legs.

He has made 48 so far. How many tables can he make?

How many more legs does he need for one more table?



\_\_\_\_\_

\_\_\_\_\_



Complete the grid by filling in the answers

2	3	4	5	8	10	11	12
$\times 3$							
$\times 4$							

Date: .....

### Count in 50s

One child, one blanket!

How many children? Estimate, then count.



**Blanket of Hope**  
Keep our children warm  
NPO  
123-098

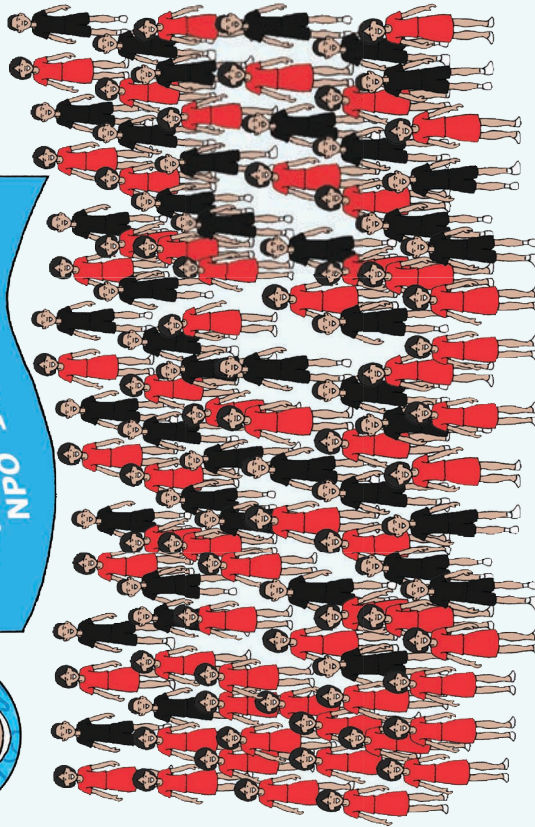

All the children in the picture get a blanket.  
How many children are there? \_\_\_\_\_

Estimate	Count	Compare
How many are 😊 boys? _____ How many are 😊 girls? _____		

- 1
- 2
- 3
- 4
- 5
- 6
- 7
- 8
- 9
- 10

**2** What do they pay?

Gwazi buys 2 R

Mrs Chaane buys 5 R

She pays R

Thambi Stores buy 20 R

**Donate now!**  
R50 for 1 blanket

5	for R50 = R250	10	for R50 = R500
4	for R50 = R _____	15	for R50 = R _____
3	for R50 = R _____	6	for R50 = R _____
7	for R50 = R _____	12	for R50 = R _____
8	for R50 = R _____	9	for R50 = R _____

**How long will it take? Use a calendar.**

The grade 3 class collects money to buy 4 blankets.

They collect R5 a day for 5 days a week.

How many weeks do they need to collect money for the blankets?

- 11
- 12
- 13
- 14
- 15
- 16
- 17
- 18
- 19
- 20

Date: .....

### Fractions: halves and quarters

Divide the balls equally between the boxes.

• How many balls are in each box? <input type="text"/>	• How many balls are in each box? <input type="text"/>
• How many balls in the purple box? <input type="text"/>	• How many balls in the purple box? <input type="text"/>
• What fraction is in the purple box? <input type="text"/>	• What fraction is in the purple box? <input type="text"/>



Look at the pictures and answer the questions.

How many circles do you count? <input type="text"/>	How many circles do you count? <input type="text"/>
What is $\frac{1}{2}$ of the circles? <input type="text"/>	What is $\frac{1}{4}$ of the circles? <input type="text"/>
	What is $\frac{2}{4}$ of the circles? <input type="text"/>
	What is $\frac{3}{4}$ of the circles? <input type="text"/>
	What is $\frac{4}{4}$ of the circles? <input type="text"/>



		<input type="text"/>
		<input type="text"/>
		<input type="text"/>
		<input type="text"/>

Colour in  $\frac{1}{2}$  of each shape.

Colour in  $\frac{1}{4}$  of each shape.

Colour in  $\frac{2}{4}$  of each shape.

Colour in  $\frac{3}{4}$  of each shape.



Look at the fraction strips.

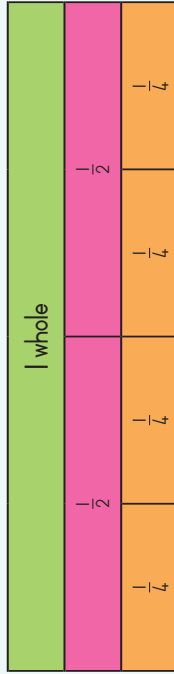

a. How many halves ( $\frac{1}{2}$ ) make one whole?

How many quarters ( $\frac{1}{4}$ ) make one whole?

How many quarters ( $\frac{1}{4}$ ) make one half?

b. Look at the diagrams and write a fraction for the shaded part.

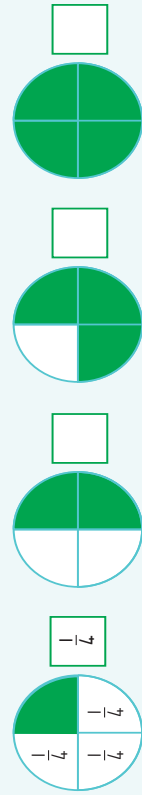

c. Which fraction is bigger  $\frac{1}{2}$  or  $\frac{1}{4}$ .

Teacher:

Sign:

Date:

Date: .....

### Fractions: halves, thirds and sixths

Divide the cans (cylinders) equally between the boxes.

Total cans: 12	How many cans in the purple box? 6	What fraction is in the purple box? $\frac{1}{2}$



Look at the pictures and answer the questions.

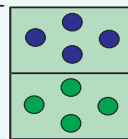

How many circles do you count?

What is  $\frac{1}{2}$  of the circles?

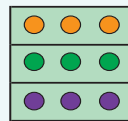

What is  $\frac{1}{3}$  of the circles?

What is  $\frac{2}{3}$  of the circles?

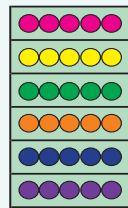

What is  $\frac{3}{6}$  of the circles?

What is  $\frac{4}{6}$  of the circles?

What is  $\frac{5}{6}$  of the circles?



- Show one half of the length of the ruler. This equals to \_\_\_\_\_ cm
- Show one third of the length on the ruler. This equals to \_\_\_\_\_ cm
- Show one sixth of the length on the ruler. This equals to \_\_\_\_\_ cm



Look at the fraction strips. Complete the sentences.

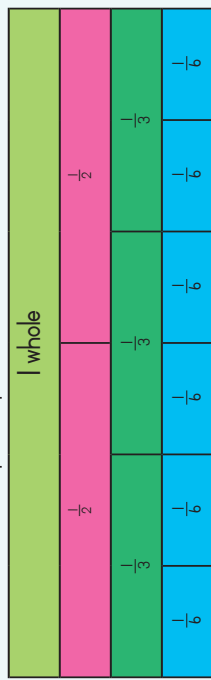

- There are \_\_\_\_\_ halves in a whole.
- There are \_\_\_\_\_ thirds in a whole.
- There are \_\_\_\_\_ sixths in a whole.
- There are \_\_\_\_\_ sixths in a half.
- There are \_\_\_\_\_ sixths in a third.



Write a fraction for the shaded part.

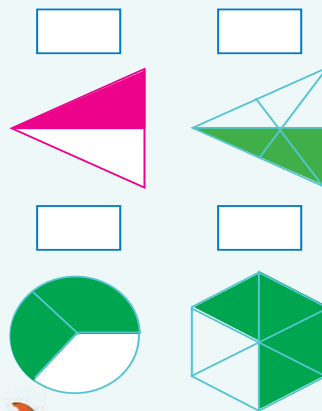

Circle the bigger fraction.

- a.  $\frac{1}{2}$     $\frac{1}{3}$
- b.  $\frac{1}{2}$     $\frac{1}{6}$
- c.  $\frac{1}{2}$     $\frac{2}{6}$

Teacher: \_\_\_\_\_  
Sign: \_\_\_\_\_  
Date: \_\_\_\_\_



Date: .....



### Fractions: fifths

Divide the cans into the 5 boxes.

- In one fifth of the boxes are  cans.
- In two fifths of the boxes are  cans.
- In three fifths of the boxes are  cans.
- In four fifths of the boxes are  cans.
- In five fifths of the boxes are  cans.



Look at the picture and answer the questions.



- How many chocolates are in the box?
- one fifth ( $\frac{1}{5}$ ) of the chocolates equal to
  - two fifths ( $\frac{2}{5}$ ) of the chocolates equal to
  - three fifths ( $\frac{3}{5}$ ) of the chocolates equal to
  - four fifths ( $\frac{4}{5}$ ) of the chocolates equal to
  - five fifths ( $\frac{5}{5}$ ) of the chocolates equal to
- On day 1 I ate  $\frac{1}{5}$  of the chocolates. How many chocolates are left?
- On day two I ate another  $\frac{1}{5}$ . How many chocolates are left?



Colour  $\frac{1}{5}$  of the measurement of the ruler.



Look at the fraction strips and answer the questions.

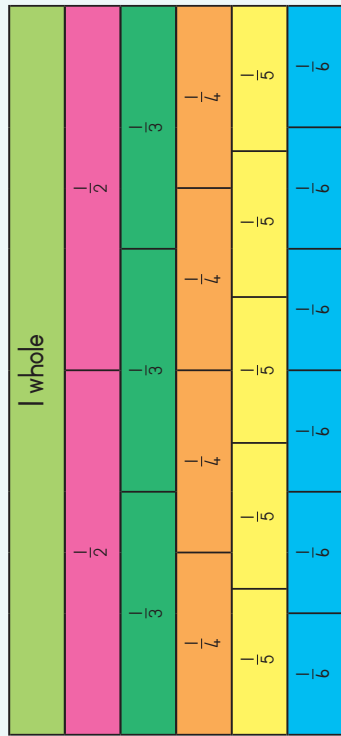

Circle bigger or smaller

- $\frac{1}{2}$  is **(bigger)** /smaller than  $\frac{1}{4}$ .
- $\frac{1}{3}$  is bigger/smaller than  $\frac{1}{2}$ .
- $\frac{1}{5}$  is bigger/smaller than  $\frac{1}{6}$ .
- $\frac{1}{6}$  is bigger/smaller than  $\frac{1}{3}$ .
- $\frac{3}{6}$  is bigger/smaller than  $\frac{2}{6}$ .



Teacher: \_\_\_\_\_  
Sign: \_\_\_\_\_  
Date: \_\_\_\_\_

Date: .....

### 3D objects

Count the boxes (prisms).

Count the balls (spheres).

Count the cylinders.

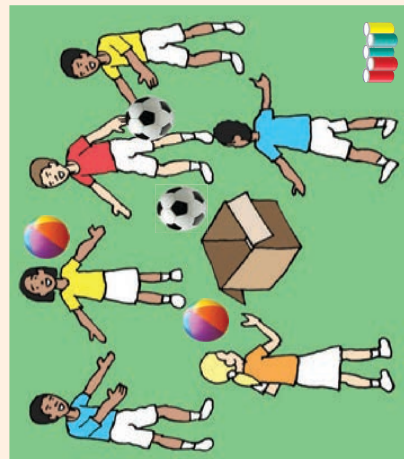

These are all boxes.

Use Cut-out sheets 3 and 4, to make them.

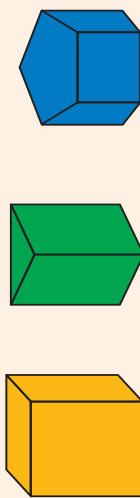

Each flat surface is called a face. Stick or draw one smiley on each face of the boxes.

How many faces did you stick on:

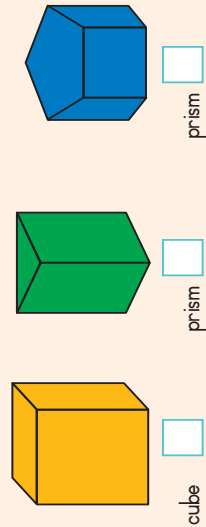

cube  prism  prism

Are the faces of the prisms flat or curved?

Now make the cylinder from Cut-out sheet 4.

Are the faces of the cylinder flat or curved?



Use your objects to build the following.

Describe the position of the cylinder using the words.

On the side

In front

On top





Use the words below to complete the sentences.



The girl looks at the \_\_\_\_\_ of the building.

The man looks at the \_\_\_\_\_ of the building.

The bird looks at the \_\_\_\_\_ of the building.

side

front

top

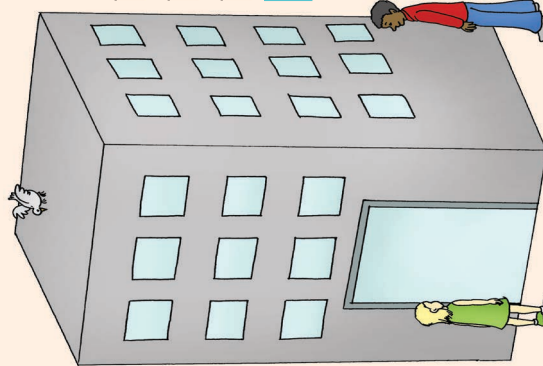

Teacher: \_\_\_\_\_  
Sign: \_\_\_\_\_  
Date: \_\_\_\_\_

Date: .....

### Double and half

Do you remember? 2 is half of 4      4 is double 2  
 20 is half of 40      40 is double 20  
 200 is half of 400      400 is double 200

Remember! We can show this in a drawing ...

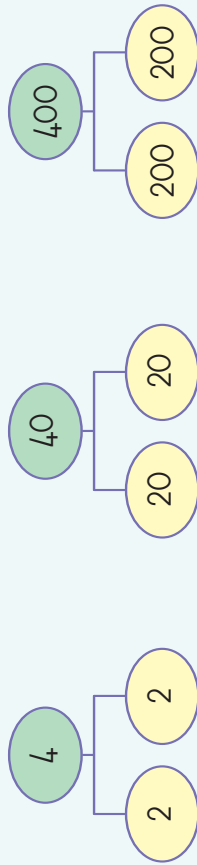

### Finding halves

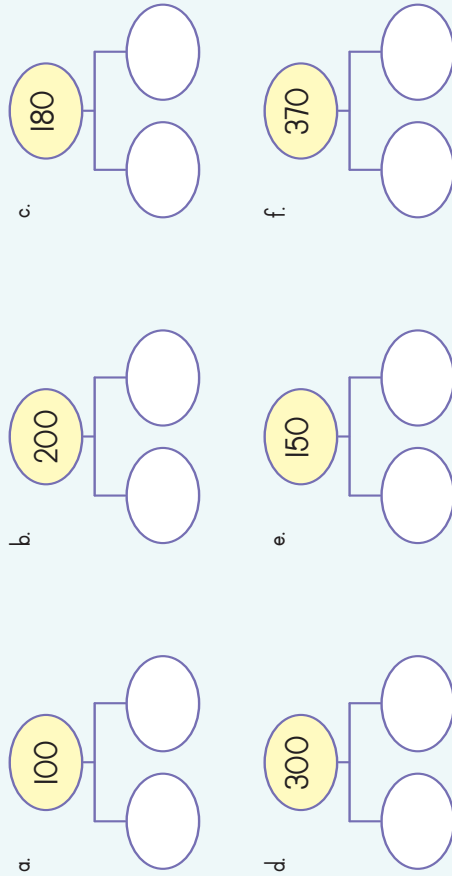

Double the number using a number line. The first example is given to you.

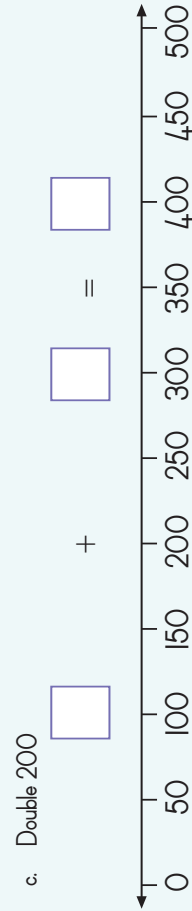
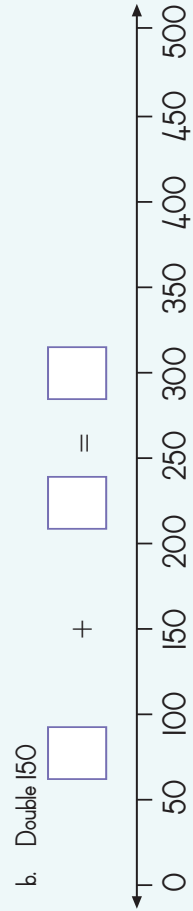
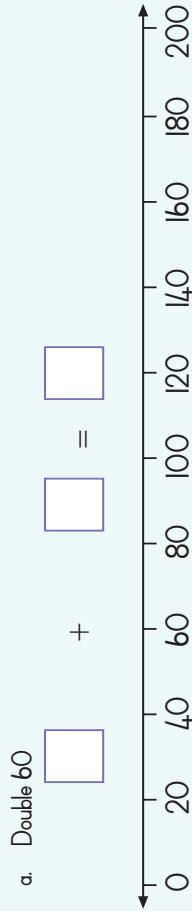
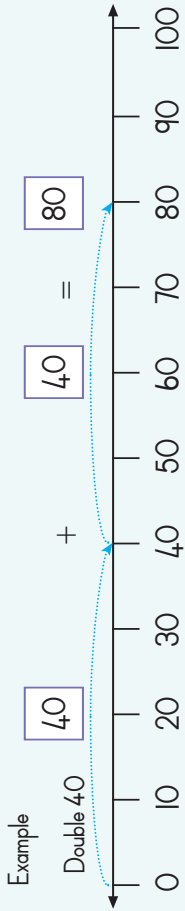

Complete the following

a. Double 100	200
b. Double 150	
c. Double 120	
d. Double 200	
e. Double 170	

Complete the following

a. Half 220	110
b. Half 180	
c. Half 260	
d. Half 60	
e. Half 320	

Teacher: \_\_\_\_\_  
 Sign: \_\_\_\_\_  
 Date: \_\_\_\_\_

### More double and halving

Finding the doubles or halves

a.

b. 148

c.

d. 134

e. 166

f.

**Sale R450**  
Half price: was R900

### Saving for a bicycle

Aakar saves R25 a week to buy this bicycle. For how many weeks must he save?

Answer:  weeks

### On sale

All the items are on sale for half the price. Write the sale price next to each item.

a. Blankets R190  
Sale price

b. Sheets R154  
Sale price

c. Cushions R54  
Sale price

d. Chairs R220  
Sale price

### 14 How many rands?

R135  
Musa wants the shirt. He only has half the amount. How much does he still need? R

R78,50  
Aakar's shoes cost twice as much as these. How much do Aakar's shoes cost? R

R97  
Phindi's dress is double the price of this one. How much does Phindi's dress cost? R

### 5 What goes in? What comes out?

Follow the example. Fill in the missing numbers.

a.

b.

Teacher:   
Sign:   
Date:

Date: .....



### Group and combine



#### Grouping the children

Mrs Ndaba wants to divide the class into equal-sized groups for outdoor games. First, she puts them into groups of 4.

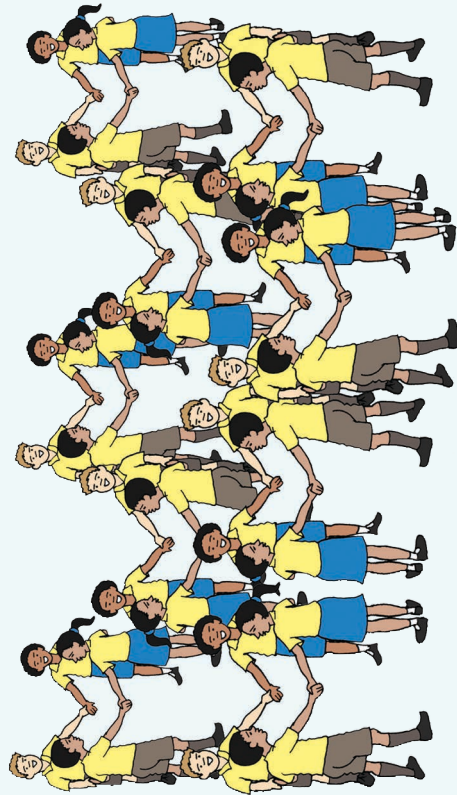

a. Count the children?

b. How many teams does she make?

c. Show all the other ways they can be grouped into equal sized groups.

\_\_\_\_\_

\_\_\_\_\_

\_\_\_\_\_

Check. Compare.  
Correct.

### How many outfits?

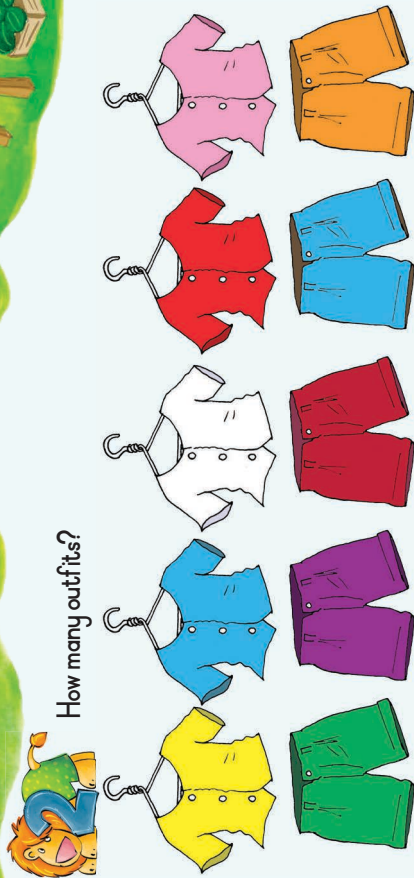

Phindi has 5 coloured shirts and 5 coloured shorts.

How many different outfits can she make using different combinations of the colours?

For example: Blue shirt/blue shorts. Blue shirt/orange shorts.

Write the first letter of each colour. Show all the other possible outfits.

\_\_\_\_\_

\_\_\_\_\_

\_\_\_\_\_

\_\_\_\_\_

\_\_\_\_\_

Predict: What, if Phindi has 6 different colours of shirts and shorts?

How many outfits can she make?

Check. Compare.  
Correct.

Teacher: \_\_\_\_\_  
Sign: \_\_\_\_\_  
Date: \_\_\_\_\_



Date: \_\_\_\_\_

### Maths fun

#### Look for a rule

Use the rule to find the missing numbers.

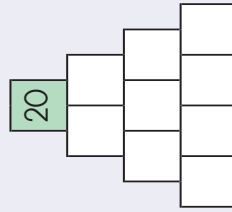
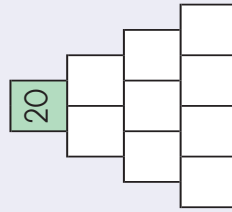
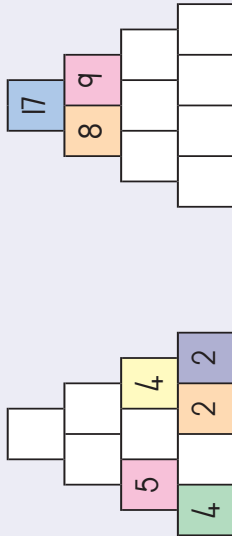
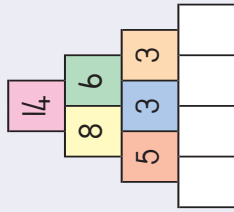

Now do these:

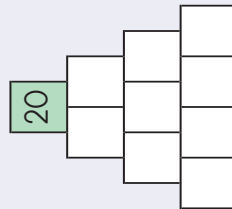
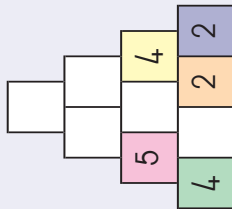

Build to 20 in 3 different ways.

### Finding the numbers



a. Rule: The numbers in each row must add up to 16.

2	5	3	6
			2

b. Rule: The 3 numbers, across the rows and down the columns, add up to the same total.

2	7	6
9		1
	3	8

23	28	21
12		26
		10

c. Rule: Write in any 5 numbers that add up to the middle number inside the star.

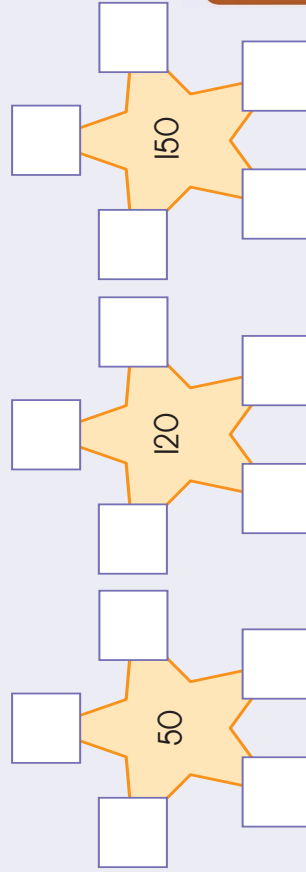

#### Challenge



Just think!

Use the numbers 1, 2, 3, 4, and 5.

The 3 numbers in each row must add up to 10.

Rule: Use each number only once.

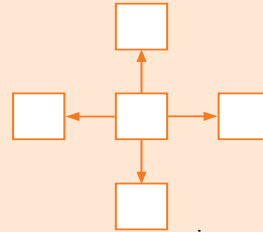

1	1	0	1	0	0
2	2	0	2	0	0
3	3	0	3	0	0
4	4	0	4	0	0
5	5	0	5	0	0
6	6	0	6	0	0
7	7	0	7	0	0
8	8	0	8	0	0
9	9	0	9	0	0

